

Service Manual

AV Control Stereo Receiver



Receiver

SA-EX310

Colour

(K) Black Type



Area

Suffix for Model No.	Area	Colour
(E)	Europe	(K)
(EB)	Great Britain	
(EG)	Germany and Italy	

* Manufactured under license from Dolby Laboratories Licensing Corporation. Additionally licensed under one or more of the following patents: U.S. numbers 3,632,886,3,746,792 and 3,959,590; Canadian numbers 1,004,603 and 1,037,877.

"Dolby" and the double-D symbol are trade marks of Dolby Laboratories Licensing Corporation.

SPECIFICATIONS\ТЕХНИЧЕСКИЕ ХАРАКТЕРИСТИКИ
PROTECTION CIRCUITRY\СИСТЕМА ЗАЩИТЫ
CAUTION FOR AC MAIN LEADS\МЕРЫ БЕЗОПАСНОСТИ ПРИ РАБОТЕ СО ШНУРОМ ПИТАНИЯ ПЕРЕМЕННОГО ТОКА
OPERATION CHECKS AND MAIN COMPONENT REPLACEMENT PROCEDURES\ПРОВЕРКА РАБОТСПОСОБНОСТИ И ЗАМЕНА ОСНОВНЫХ КОМПОНЕНТОВ
FAN MOTOR TROUBLESHOOTING\НЕИСПРАВНОСТИ ДВИГАТЕЛЯ ОХЛАЖДЕНИЯ ТРОUBLESHOOTING\НЕИСПРАВНОСТИ И МЕТОДЫ ИХ УСТРАНЕНИЯ
BLOCK DIAGRAM\БЛОК-СХЕМА
TERMINAL FUNCTIONS OF IC's\ФУНКЦИОНАЛЬНОЕ НАЗНАЧЕНИЕ ВЫВОДОВ ИНТЕГРАЛЬНЫХ МИКРОСХЕМ
TERMINAL GUIDE OF IC's, TRANSISTORS & DIODES\ЦОКОЛЕВКА ВЫВОДОВ ИНТЕГРАЛЬНЫХ МИКРОСХЕМ, ТРАНЗИСТОРОВ И ДИОДОВ
SCHEMATIC DIAGRAMS\ПРИНЦИПИАЛЬНЫЕ СХЕМЫ
PRINTED CIRCUIT BOARDS\ПЕЧАТНЫЕ ПЛАТЫ
WIRING CONNECTION DIAGRAM\СХЕМА СОЕДИНЕНИЯ
CABINET PARTS LOCATION\РАСПОЛОЖЕНИЕ ЧАСТЕЙ КОРПУСА
REPLACEMENT PARTS LIST\СПИСОК ЗАПАСНЫХ ЧАСТЕЙ
RESISTORS & CAPACITORS\РЕЗИСТОРЫ И КОНДЕНСАТОРЫ
PACKAGING\УПАКОВКА

Technics®

© 1997 Matsushita Electronics (S) Pte. Ltd.
 All rights reserved. Unauthorized copying and distribution is a violation of law.

■ Specifications

■ FM Tuner Section

Frequency range	87.50 — 108.00 MHz
Sensitivity	
S/N 30 dB	1.5 μ V / 75 Ω
S/N 26 dB	1.3 μ V / 75 Ω
S/N 20 dB	1.2 μ V / 75 Ω
IHF usable sensitivity	1.5 μ V / 75 Ω (IHF '58)
IHF 46 dB stereo quieting sensitivity	22 μ V / 75 Ω
Total harmonic distortion	
MONO	0.2%
STEREO	0.3%
S/N	
MONO	60 dB (75 dB, IHF)
STEREO	58 dB (71 dB, IHF)
Frequency response	20Hz — 15 kHz (+1dB, -2dB)
Alternate channel selectivity \pm 400 kHz	65 dB
Capture ratio	1 dB
Image rejection at 98MHz	40 dB
IF rejection at 98MHz	70 dB
Spurious response rejection at 98MHz	70 dB
AM suppression	50 dB
Stereo separation 1kHz	40 dB
Carrier leak 19kHz	-30 dB (-35 dB, IHF)

IF rejection (at 999 kHz) 55 dB

■ Amplifier Section

Power output (at 240 V)	
DIN 1 kHz (T.H.D. 1%)	2 X 60 W(4 Ω)
40 Hz-20 kHz continuous power output both channels driven	2 X 40 W(8 Ω)
Total harmonic distortion	
Rated power at 40 Hz – 20kHz	0.8 % (8 Ω)
Half power at 1 kHz	0.07 % (8 Ω)
Power output at the Dolby Pro Logic operation	
DIN 1 kHz (T.H.D. 1 %)	
Front	2 X 50 W (4 Ω)
Center	50 W (8 Ω)
Surround	50 W (8 Ω)
Damping factor	30 (8 Ω)
Load impedance	
Front	4 - 16 Ω
Center	8 - 16 Ω
Surround	4 - 16 Ω
Power bandwidth both channels driven, -3 dB	10 Hz - 40 kHz (8 Ω)
Intermodulation distortion rated	
power at 60 Hz : 7 kHz = 4:1, SMPTE	0.5 % (8 Ω)
Frequency response	
PHONO	RIAA standard curve(30Hz-15kHz) \pm 0.8 dB
CD, TAPE, VCR, TV/DVD	10Hz – 40kHz, \pm 3 dB
Input sensitivity and impedance	
PHONO	3 mV / 47 k Ω
CD, TAPE, VCR, TV/DVD	200 mV / 22 k Ω
S/N at rated power (8 Ω)	
PHONO	70 dB (IHF, A: 80 dB)
CD, TAPE, VCR, TV/DVD	75 dB (IHF, A: 85 dB)

■ Protection Circuitry

The protection circuitry may have operated if either of the following conditions are noticed:

- No sound is heard when the power is turned on.
- Sound stops during a performance.

The function of this circuitry is to prevent circuitry damage if, for example, the positive and negative speaker connection wires are "shorted", or if speaker systems with an impedance less than

38kHz	-50 dB (-55 dB, IHF)
Channel balance (250 Hz - 6.3 kHz)	\pm 1.5 dB
Limiting point	1.2 μ V
Bandwidth	
IF amplifier	180 kHz
FM demodulator	1000 kHz
Antenna terminal(s)	75 Ω (unbalanced)

■ Video Section

Output voltage at 1V input (unbalanced)	1 \pm 0.1 Vp-p
Maximum input voltage	1.5 Vp-p
Input/output impedance	75 Ω (unbalanced)

■ AM Tuner Section

Frequency range	AM	
	(9 kHz steps)	522 — 1611 kHz
	(10 kHz steps)	530 — 1620 kHz
Sensitivity		20 μ V, 330 μ V / m
Selectivity (at 999 kHz)		55 dB
Image rejection (at 999 kHz)		40 dB

Tone controls	
BASS	50 Hz , +10 to -10 dB
TREBLE	20 kHz, +10 to -10 dB
Output voltage	
TAPE REC (OUT), VCR OUT	200 mV
Channel balance (250 Hz - 6.3 kHz)	\pm 1 dB
Channel separation	55 dB
Headphones output level and impedance	430 mV / 330 Ω
Subwoofer frequency response	7 –100 Hz, \pm 3 dB

■ General

Power consumption	160 W
Power supply	
E, EG	AC 230 V, 50 Hz
EB	AC 230 - 240 V, 50 Hz
Dimensions (W x H x D)	430 x 136 x 309 mm
Weight	7.3 kg

Notes :

1. Specifications are subject to change without notice. Weight and dimensions are approximate.
2. Total harmonic distortion is measured by the digital spectrum

the indicated rated impedance of the amplifier are used. If this occurs, follow the procedure outlines below:

1. Turn off the power.
2. Determine the cause of the problem and correct it.
3. Turn on the power once again after one minute.

Note:

When the protection circuitry functions, the unit will not operate unless the power is first turned off and then on again.

■ Caution for AC Main Leads



(For “EB” area code model only.)

For your safety, please read the following text carefully.

This appliance is supplied with a moulded three pin mains plug for your safety and convenience.

A 5-ampere fuse is fitted in this plug.

Should the fuse need to be replaced please ensure that the replacement fuse has a rating of 5-ampere and that it is approved by ASTA or BSI to BS1362.

Check for the ASTA mark  or the BSI mark  on the body of the fuse.

If the plug contains a removable fuse cover you must ensure that it is refitted when the fuse is replaced.

If you lose the fuse cover, the plug must not be used until a replacement cover is obtained.

A replacement fuse cover can be purchased from your local dealer.

CAUTION!

IF THE FITTED MOULDED PLUG IS UNSUITABLE FOR THE SOCKET OUTLET IN YOUR HOME THEN THE FUSE SHOULD BE REMOVED AND THE PLUG CUT OFF AND DISPOSED OFF SAFELY.

THERE IS A DANGER OF SEVERE ELECTRICAL SHOCK IF THE CUT OFF PLUG IS INSERTED INTO ANY 13-AMPERE SOCKET.

If a new plug is to be fitted, please observe the wiring code as shown below.

If in any doubt please consult a qualified electrician.

IMPORTANT

The wires in this mains lead are coloured in accordance with the following code:

Blue: Neutral
Brown: Live

As these colours may not correspond with the coloured markings identifying the terminals in your plug, proceed as follows:

The wire which is coloured Blue must be connected to the terminal which is marked with the letter N or coloured Black or Blue.

The wire which is coloured Brown must be connected to the terminal which is marked with the letter L or coloured Brown or Red.

WARNING: DO NOT CONNECT EITHER WIRE TO THE EARTH TERMINAL WHICH IS MARKED WITH THE LETTER E, BY THE EARTH SYMBOL OR COLOURED GREEN OR GREEN/YELLOW.

THIS PLUG IS NOT WATERPROOF—KEEP DRY.

Before use

Remove the connector cover.

How to replace the fuse

The location of the fuse differ according to the type of AC mains plug (figures A and B). Confirm the AC mains plug fitted and follow the instructions below.

Illustrations may differ from actual AC mains plug.

1. Open the fuse cover with a screwdriver.

Figure A

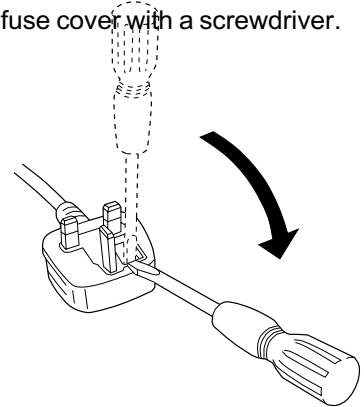
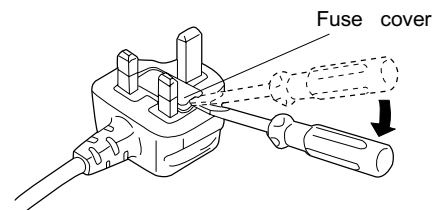

Figure B



2. Replace the fuse and close or attach the fuse cover.

Figure A

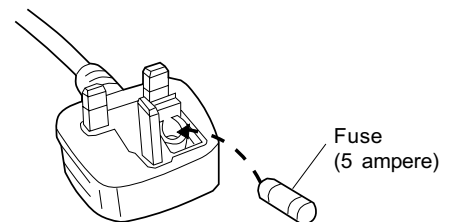
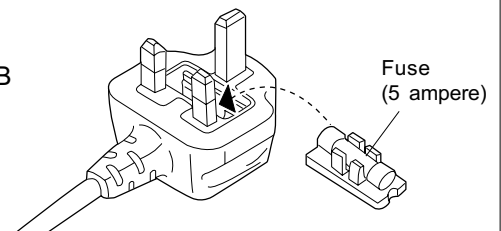

Figure B



■ Operation Checks and Main Component Replacement Procedures

"ATTENTION SERVICER" Some chassis components may have sharp edges. Be careful when disassembling and servicing. Please take note that the diagrams shown are for model SA-EX510 which is similar to SA-EX310.

1. This section describes procedures for checking the operation of the major printed circuit boards and replacing the main components.
2. For reassembly after operation checks or replacement, reverse the respective procedures. Special reassembly procedures are described only when required.
3. Select items from the following index when checks or replacement are required.

• **Contents**

- Checking Procedure For Each Major P.C.B. 4~6
- Main Component Replacement Procedures 6~8

■ Checking Procedure For Each Major P.C.B.

1. Checking of the Panel P.C.B., and Tuner P.C.B.

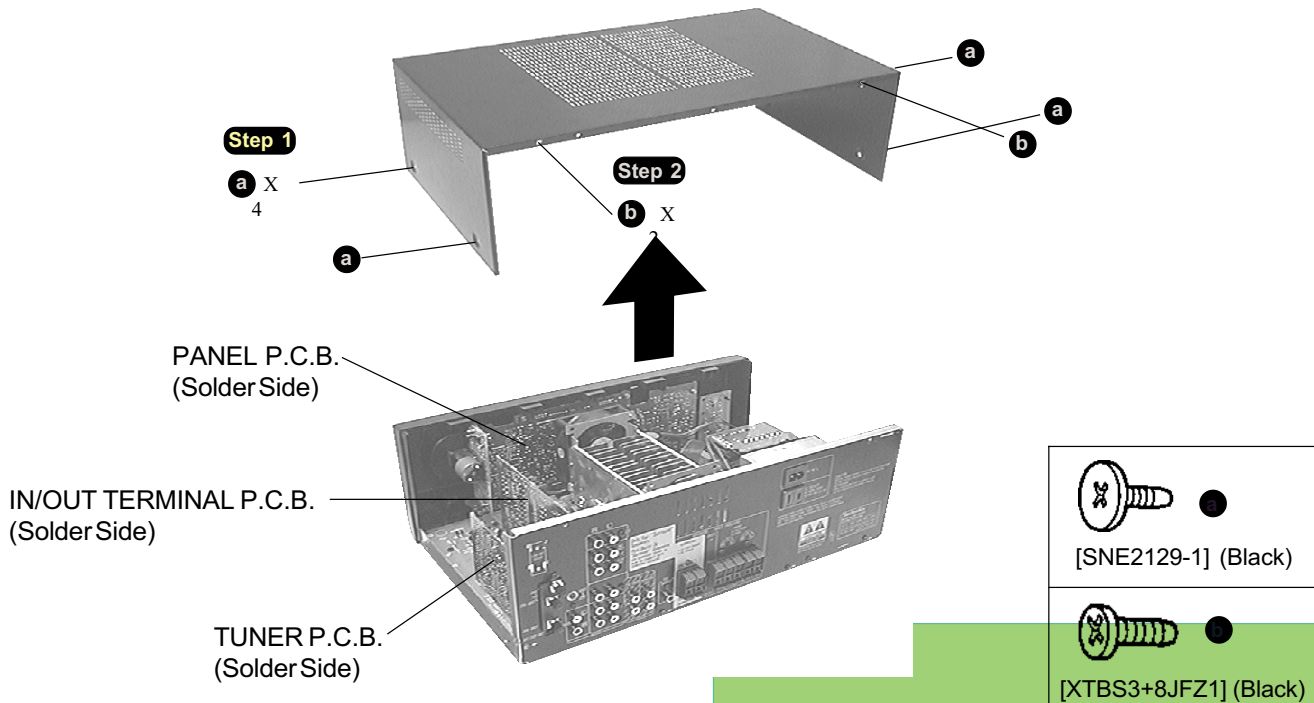

2. Checking of the In/Out Terminal P.C.B.

Step 1
Remove the top cabinet.

Step 3
Release the catch, pull the rear panel in the direction of arrow 1 and simultaneously remove the In/Out Terminal P.C.B. in the direction of arrow 2.

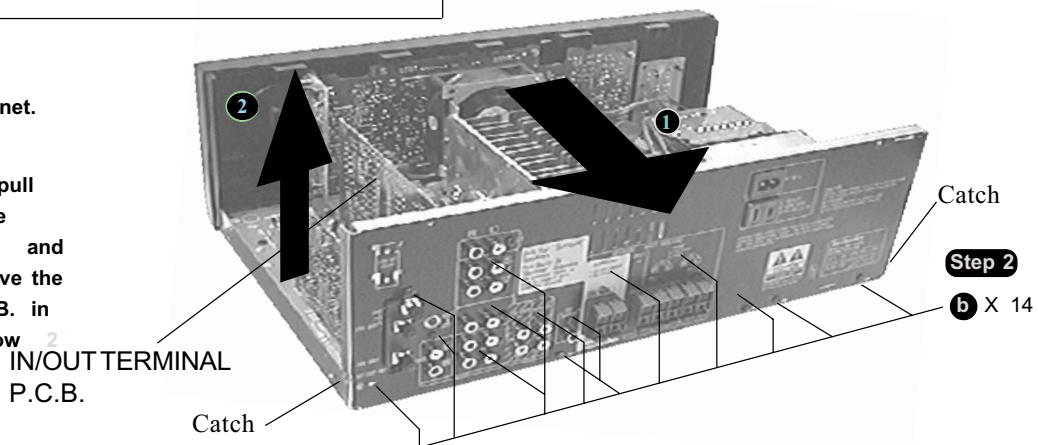

To Remove Front Panel, Panel P.C.B., Power Switch P.C.B. and Headphone Jack P.C.B.

Step 1
Remove the top cabinet.

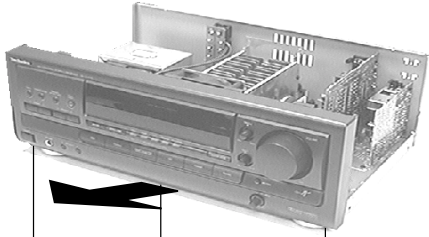

b X 3
Step 2

Step 3
Remove the front panel in the direction of arrow.

Power Switch P.C.B.

Panel P.C.B.

Headphone Jack P.C.B.

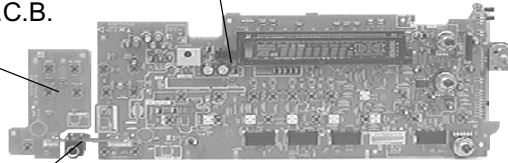

Step 8
Pull out the Headphone Jack P.C.B.

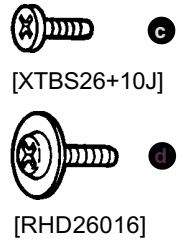

Step 4
Remove the Volume Knob and Nut.

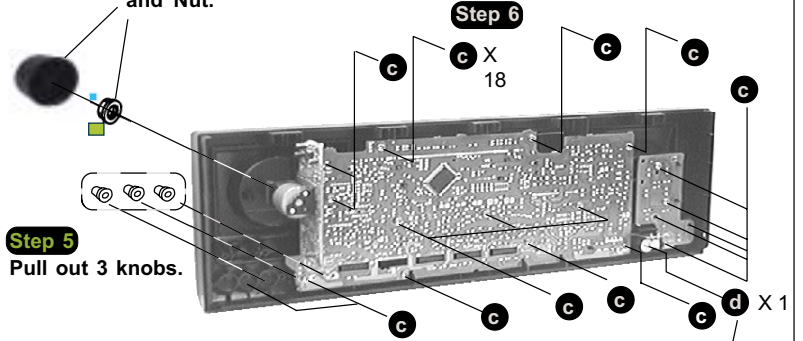

Step 5
Pull out 3 knobs.

Step 6

c X 18

Step 7

3. Checking of the MAIN P.C.B.

Step 1
Remove the top cabinet.

Step 2
Remove the front panel.

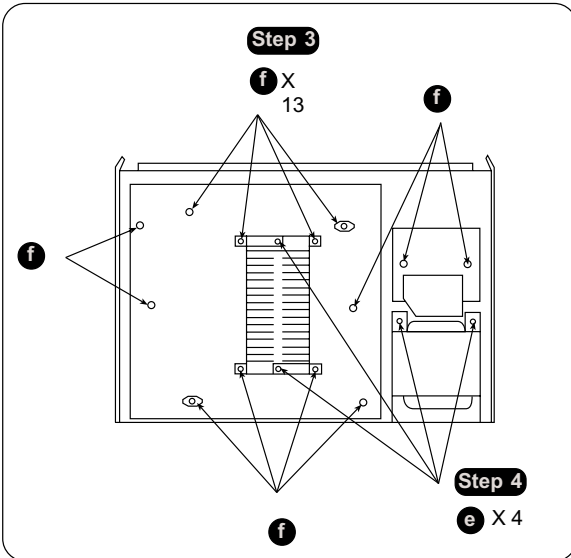

Step 6
Release 2 catches and pull the rear panel in the direction of arrow for about 10mm. (Note : Main, Tuner and In/Out Terminal P.C.B. are attach to the rear panel)

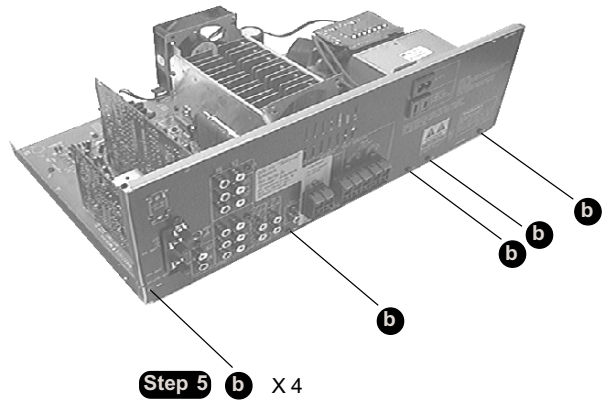

Step 5 **b** X 4

Step 7
Lift the rear panel in the direction of arrow.

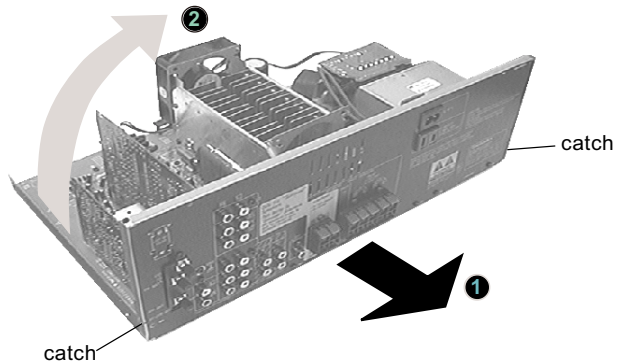

Check
Connect the front panel to the main P.C.B. as shown.

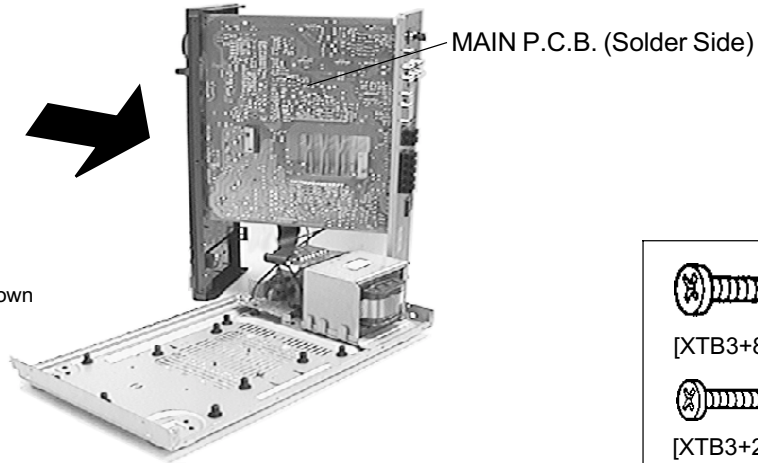

• Check the Main P.C.B. as shown

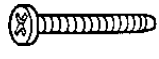
-  ●
[XTB3+8FFZ] (Black)
-  ●
[XTB3+20JFZ] (Black)

■ Main Component Replacement Procedures

1. Replacement of the Power IC and Regulator Transistor

Step 1
Remove the top cabinet.

Step 2 Cut the joints as shown below. (6 joints)

Locate the nipper to the thin portion of the joint.
Nipper
Bottom cover
Cut the joint.

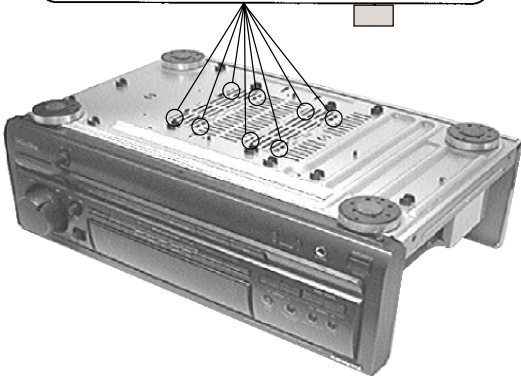

Step 3 Fold the joints. (6 joints)

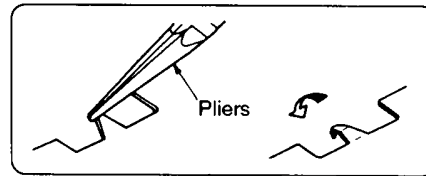

Step 4
Desolder the terminals of Power IC and Regulator Transistor.

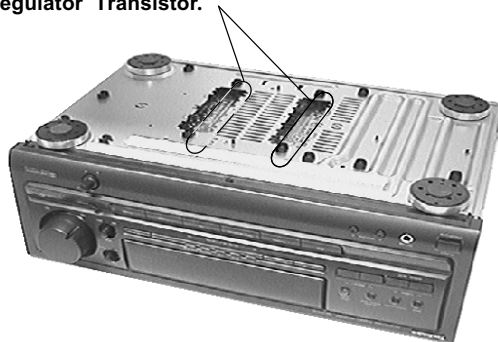

Regulator transistor
(Q701,Q708)
[2SD2374PQAU,2SB1548PQAU]

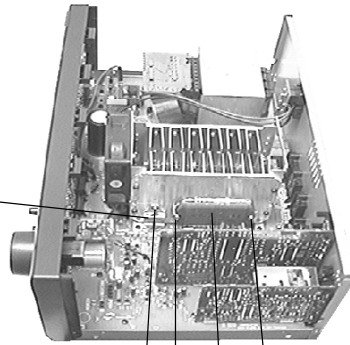

Step 5

g X 3



Power IC (IC602)
[RSN3305-P]



[XTW3+15T]

Installation of the bottom cover after replacement

Step 1

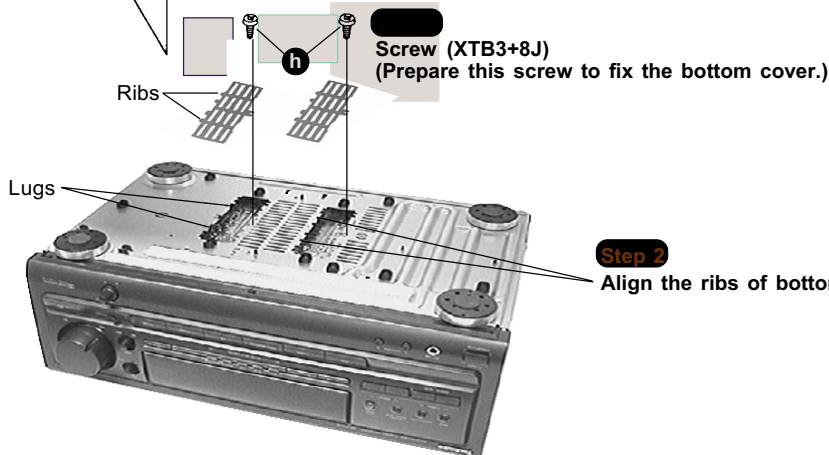
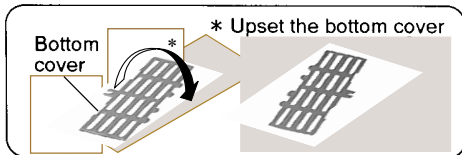

Step 2

Align the ribs of bottom cover into the lugs.



[XTB3+8J] (Black)

CAUTION

1. After replacing the power IC or regulator transistor, apply a sufficient quantity of compound grease (RFKX0002/SZZ0L15) between the heat sink and the power IC or regulator transistor (Radiation of power IC).
2. Tighten enough the screws (g) after replacing the power IC and regulator transistor. Otherwise, the heat radiation works little.
3. When installing or removing the power IC or transistor holder, be sure to use an offset screwdriver.

- A long straight screwdriver cannot be used for removing or mounting the screws since its long grip interferes with the neighbouring P.C.B. and transformer.(See Fig.1 & 3)
- A short straight screwdriver may be used for removal, but cannot be used for mounting because the limited space in the unit will not allow sufficient tightening torque.(See Fig.2 & 3)

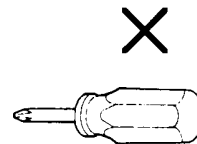

A short straight screwdriver

Fig.2

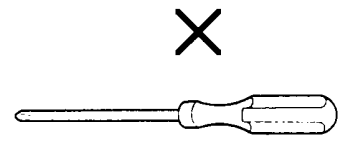

A long straight screwdriver

Fig.1

- Insufficient tightening will cause poor heat dissipation from the power IC and regulator transistor and,in the worst case, may lead to their thermal breakdown.

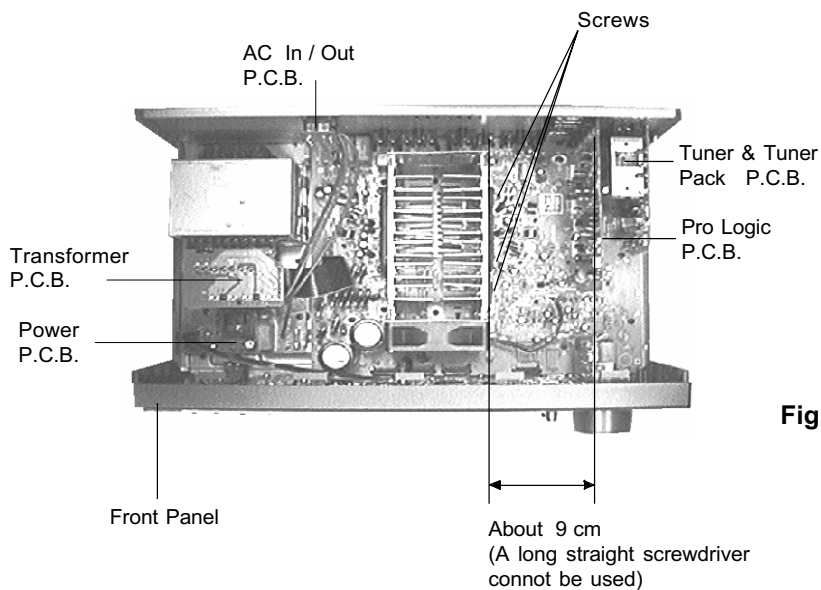
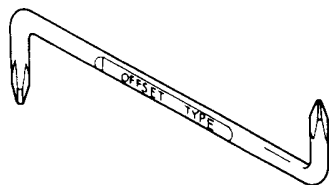

Fig.3

—OFFSET SCREWDRIVER—

•The PROTO offset screwdriver No.34-1/4 is recommended for use in the application above.



No.		
34 1/4	1 & 2	4 3/4"

•The address of PROTO International Sales is as follows.



International Sales

International Sales Office
Stanley-Proto Industrial Tools
14117 Industrial Park Blvd.
Covington, GA 30209 U.S.A.
Fax: 706-786-4387
Phone: 706-787-3800

Australia, New Zealand &
South Pacific
Stanley-Proto Industrial Tools
P.O.Box 10
400 Whitehorse Road
Nunweding 3131
Victoria, Australia
Fax: 61-3-894-1173
Phone: 61-3-878-9244

Singapore, Indonesia,
Philippines, Korea, Hong
Kong, Malaysia, China.
Stanley-Proto Asia Pacific
12 Gul Drive
Singapore 2262
Fax: 65-861-3206
Phone: 65-862-0883

Thailand
Stanley-Proto Thailand Ltd.
1017 Moo 13 Bangkaew
Amphur Bangplee
Samutprakarn, Thailand
Fax: 66-2-316-6071
Phone: 66-2-316-8655

Japan
Stanley Works Japan
2-7-16 Hyakunin-Cho
Shinjuku-ku
Tokyo 160 Japan
Fax: 81-3-3360-8456
Phone: 81-3-3360-8458

Mexico
Herramientas Stanley S.A.
DE C.V.
Apartado Postal 675
72030 Puebla, Pue, Mexico
Fax: 52-22-494-4880
Phone: 52-22-495-300

South & Central America,
Puerto Rico, The Caribbean
Stanley Inter-America
2101 N.W. 84th Ave.
Miami, Florida 33122
Fax: 305-594-4261

Phone: 305-591-3828

Europe
Stanley-Proto Europe
Woodside, Sheffield
539PD
England
Fax: 44-742-739-038
Phone: 44-742-768-888

Canada
Stanley-Proto Canada
1100 Corporate Drive
Burlington, Ontario
Canada, L7L 5R6
Fax: 416-335-0075
Phone: 416-335-0075

Middel East, Mediterranean
& Africa
Stanley-MEMA
Cory House The Ring
Bracknell Berkshire
RG 12 1A2
England
Fax: 44-344-485-526
Phone: 44-344-51813

Fan Motor Troubleshooting

The Model SA-EX310 employ fan motor error sensing electronics.

If the cooling fan is not operating and "OVER LOAD" is displayed on the FL display, check the fan motor and its driving circuit

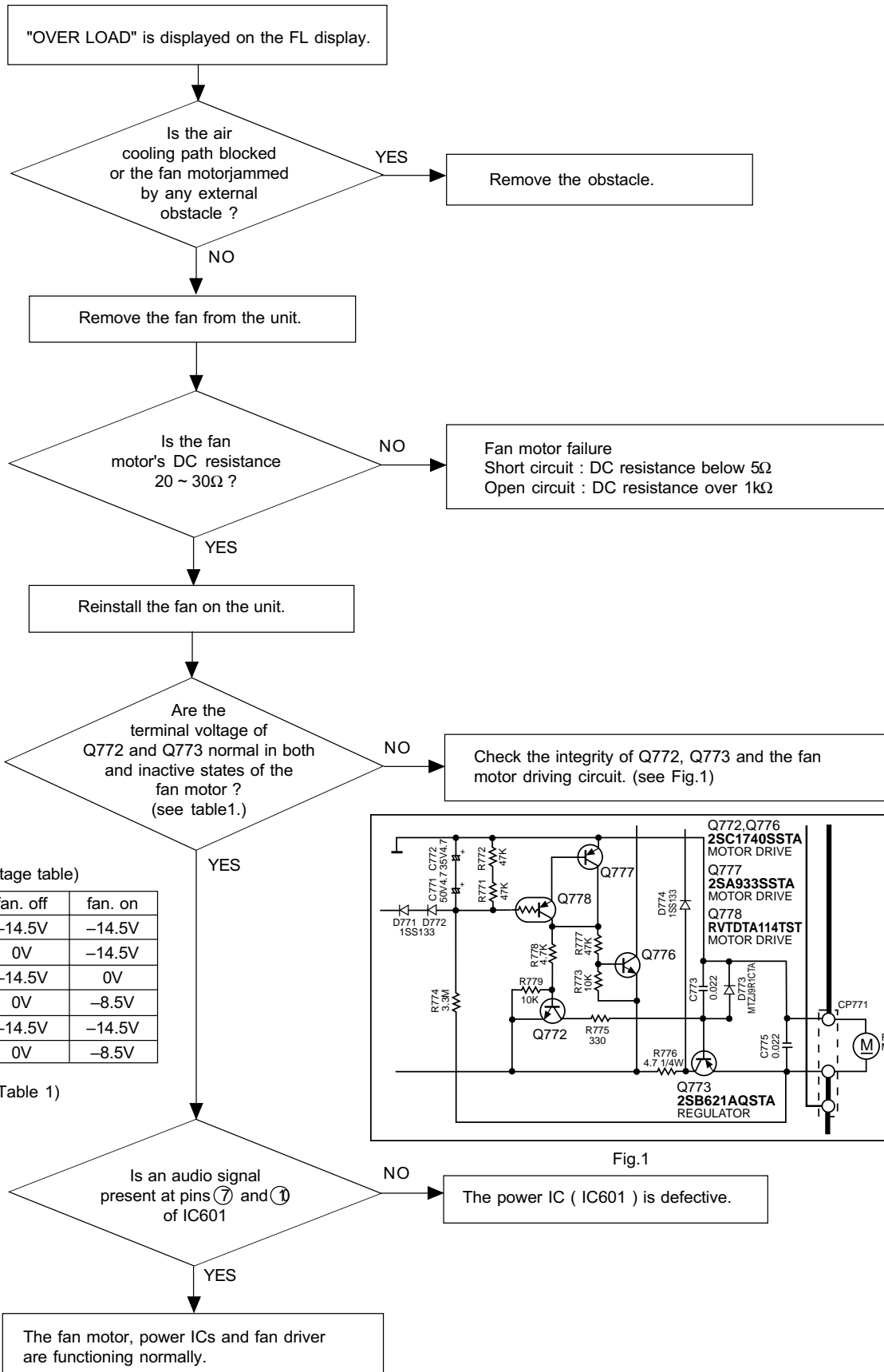

(Voltage table)

		fan. off	fan. on
Q772	E	-14.5V	-14.5V
	C	0V	-14.5V
	B	-14.5V	0V
Q773	E	0V	-8.5V
	C	-14.5V	-14.5V
	B	0V	-8.5V

(Table 1)

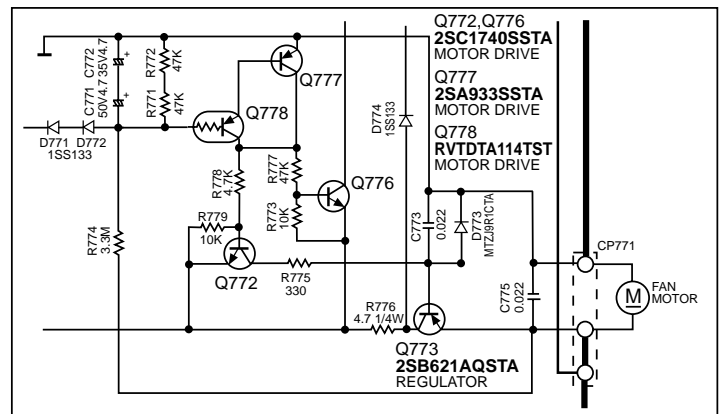

Fig.1

Troubleshooting

This unit has test points on each circuit board block for use in troubleshooting.

CONNECTION

Connect either a CD player, tape deck or AF oscillator to the input terminals of the unit.

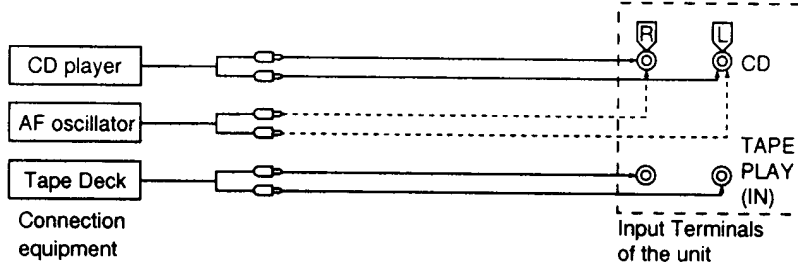

REQUIRED ITEMS

1. Testing with a CD player ——— Test disc (SZZP1054C / first program, 1kHz, 0dB)
2. Testing with a tape deck ——— Test tape (QZZCLA / 315Hz, 0dB)
3. Testing with a AF oscillator ——— Set the output at 500Hz, 200mV
4. Oscilloscope (min. 10MHz) ----- To measure the output waveform at the test points.

TEST PROCEDURE FOR AMPLIFIER CIRCUIT

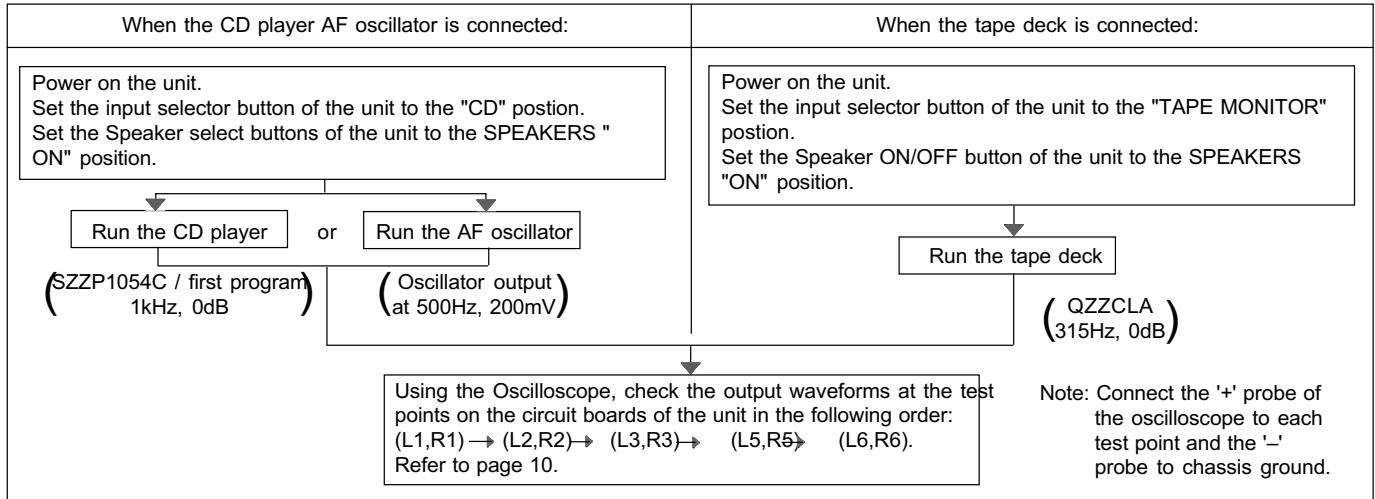

TEST POINTS POSITIONS OF AMPLIFIER CIRCUIT

MAIN P.C.B. (component side)

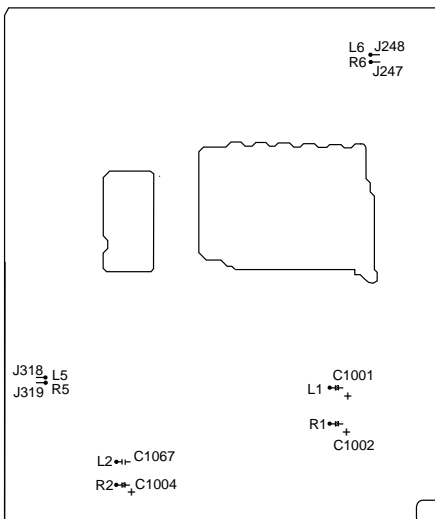

PANEL P.C.B. (component side)

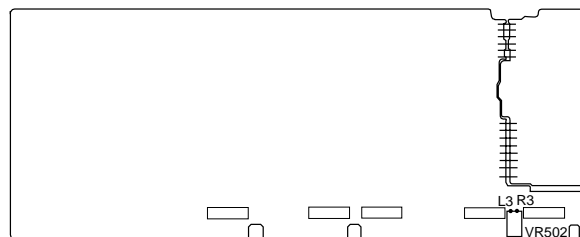

NORMAL WAVEFORMS OF AMPLIFIER CIRCUIT AND LIKELY FAULTY BLOCKS

TP	CD player	Tape deck	AF oscillator	Likely faulty block if the normal waveform shown at the left is not present.
L1/R1 area				Input selector block IC402 &
L2/R2	0.5msec 2V 	1msec 500mV 	1msec 500mV 	Dolby pro logic block IC1001 and IC1002 & area
L3/R3	0.5msec 2V 	1msec 500mV 	1msec 500mV 	Master volume block VR501 & area
L5/R5 Q602	0.5msec 500mV 	1msec 50mV 	1msec 100mV 	Power limiter block Q601 to & area
L6/R6	0.5msec 100mV* 	1msec 500mV 	1msec 500mV 	Main amplifier block IC601 & area
	0.5msec 5V*	1msec 10V	1msec 10V	

Measurement conditions.

control (VR512) and Bass control (VR511) positions

*Volume control position (VR501) for these test

Volume control (VR501), Treble

:



CHECKING PROCEDURE FOR SURROUND CIRCUIT

Outputting surround signal normally requires that opposite phase signals be applied to both the left and right channels. However, this unit incorporates a service mode, allowing the surround circuit to be tested using in-phase signals.

When the CD player or AF oscillator is connected :	When the tape deck is connected :
<div style="border: 1px solid black; padding: 5px; margin-bottom: 5px;">Power on the unit. Set the input selector button of the unit to the "CD" position.</div> <div style="text-align: center;">↓</div> <div style="border: 1px solid black; padding: 5px; margin-bottom: 5px;">While pressing both "+" and "-" of the surround level adjustment button "SURROUND, press the "Power" button.</div> <div style="text-align: center;">↓</div> <div style="border: 1px solid black; padding: 5px; margin-bottom: 5px;">The letter ^F SURROUND₂ flash on the FL display.</div> <div style="text-align: center;">↓</div> <div style="text-align: center;">Ⓐ</div>	<div style="border: 1px solid black; padding: 5px; margin-bottom: 5px;">Power on the unit. Set the input selector button of the unit to the "TAPE MONITOR" position.</div> <div style="text-align: center;">↓</div> <div style="border: 1px solid black; padding: 5px; margin-bottom: 5px;">While pressing both "+" and "-" of the surround level adjustment button "SURROUND, press the "Power" button.</div> <div style="text-align: center;">↓</div> <div style="border: 1px solid black; padding: 5px; margin-bottom: 5px;">The letter ^F SURROUND₂ flash on the FL display.</div> <div style="text-align: center;">↓</div> <div style="text-align: center;">Ⓑ</div>

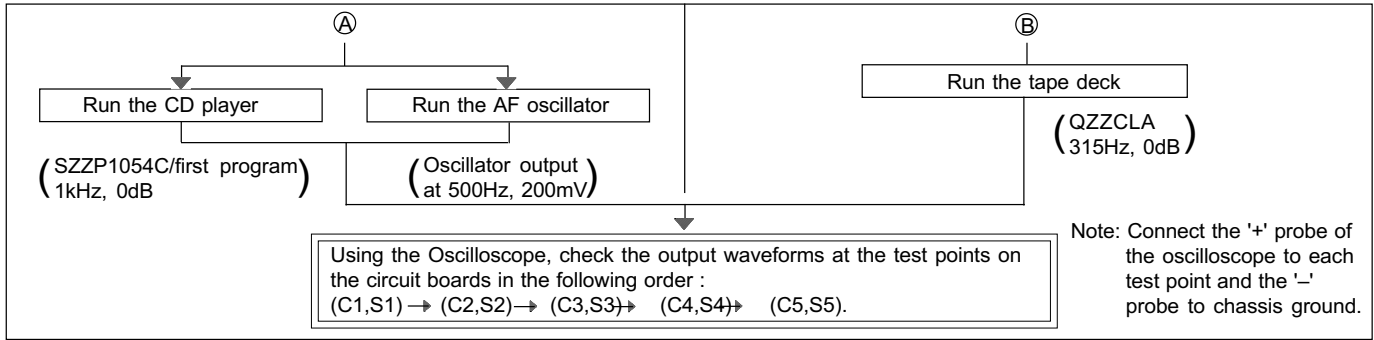

• To exit the service mode, power off the unit.

TEST POINTS POSITIONS OF SOURROUND CIRCUIT

MAIN P.C.B. (component side)

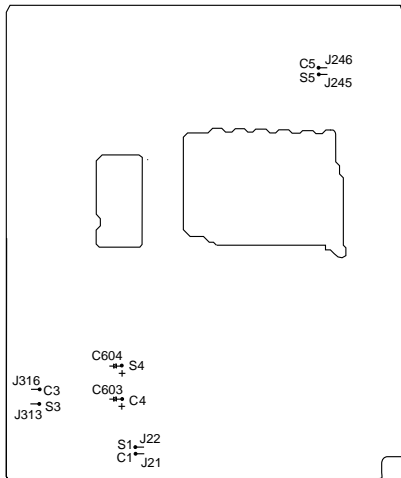

PANEL P.C.B. (component side)

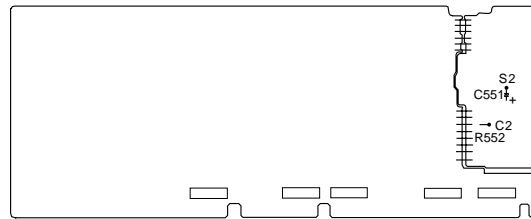

NORMAL WAVEFORMS OF AMPLIFIER CIRCUIT AND LIKELY FAULTY BLOCKS

TP	CD player	Tape deck	AF oscillator	Likely faulty block if the normal waveform shown at the left is not present.
C1 S1	 0.5msec 1V	 1msec 100mV	 1msec 200mV	Dolby pro logic block IC1001 and IC1002 & area
C2 S2	 0.5msec 200mV	 1msec 20mV	 1msec 50mV	Master volume block VR501 & area
C3 S3	 0.5msec 200mV*	 1msec 500mV	 1msec 1V	Tone control block IC551 & area

NORMAL WAVEFORMS OF AMPLIFIER CIRCUIT AND LIKELY FAULTY BLOCKS

TP	CD player	Tape deck	AF oscillator	Likely faulty block if the normal waveform shown at the left is not present.
C4 S4	 0.5msec 200mV*	 1msec 500mV	 1msec 1V	Power limiter block Q551 to Q552 & area
C5 S5	 0.5msec 5V*	 1msec 10V	 1msec 1V*	Main amplifier block IC601 & IC602 & area

Measurement conditions.
control (VR512) and Bass control (VR511) positions
*Volume control position (VR501) for these test

Volume control (VR501), Tremble
:

CIRCUIT BLOCKS

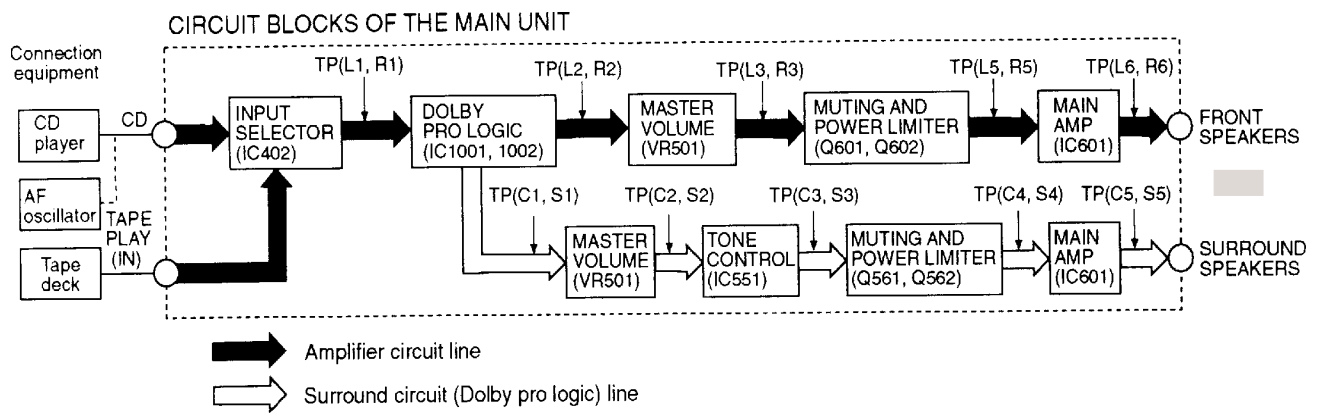

OVERLOAD DETECTION FUNCTION

The HIC protection circuit functions if any cord at a speaker terminal is short-circuited or if the unit overheats because of improper operation. At the same time, "OVERLOAD" scrolls across the FL display.
 In this state, all keys remain in operative; if any key is pressed, "SWITCH OFF POWER" scrolls across the FL display.
 If an overload occurs, immediately power off the unit and check the speaker connection, venting holes and cooling fans. After fixing any faults, power on the unit again and check for proper operation.
 If no defects are found, or if the unit remains overload after it is power on again, check the circuit for faults.

Block Diagram

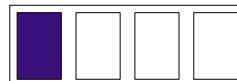
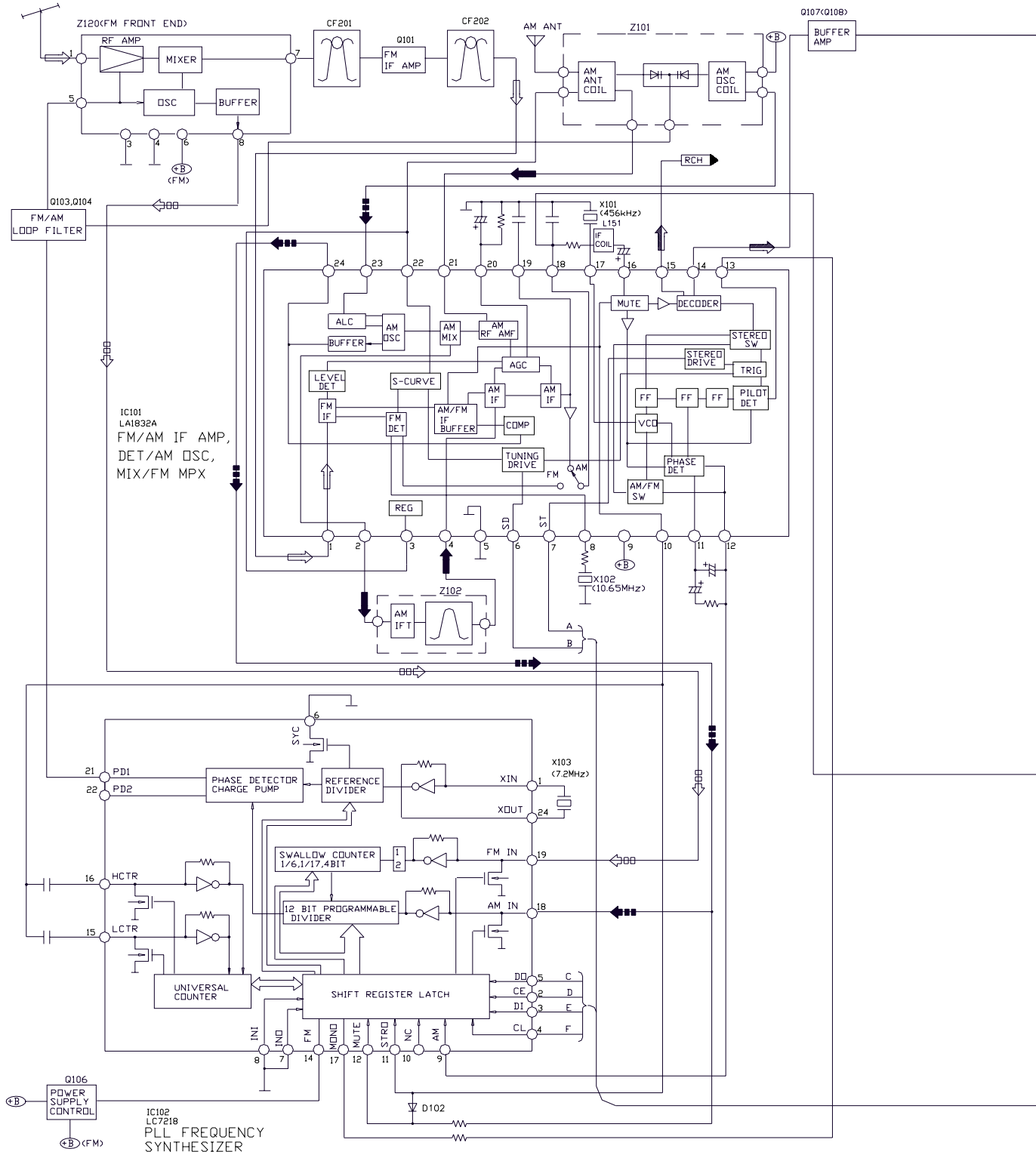

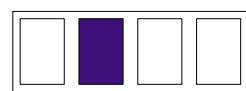
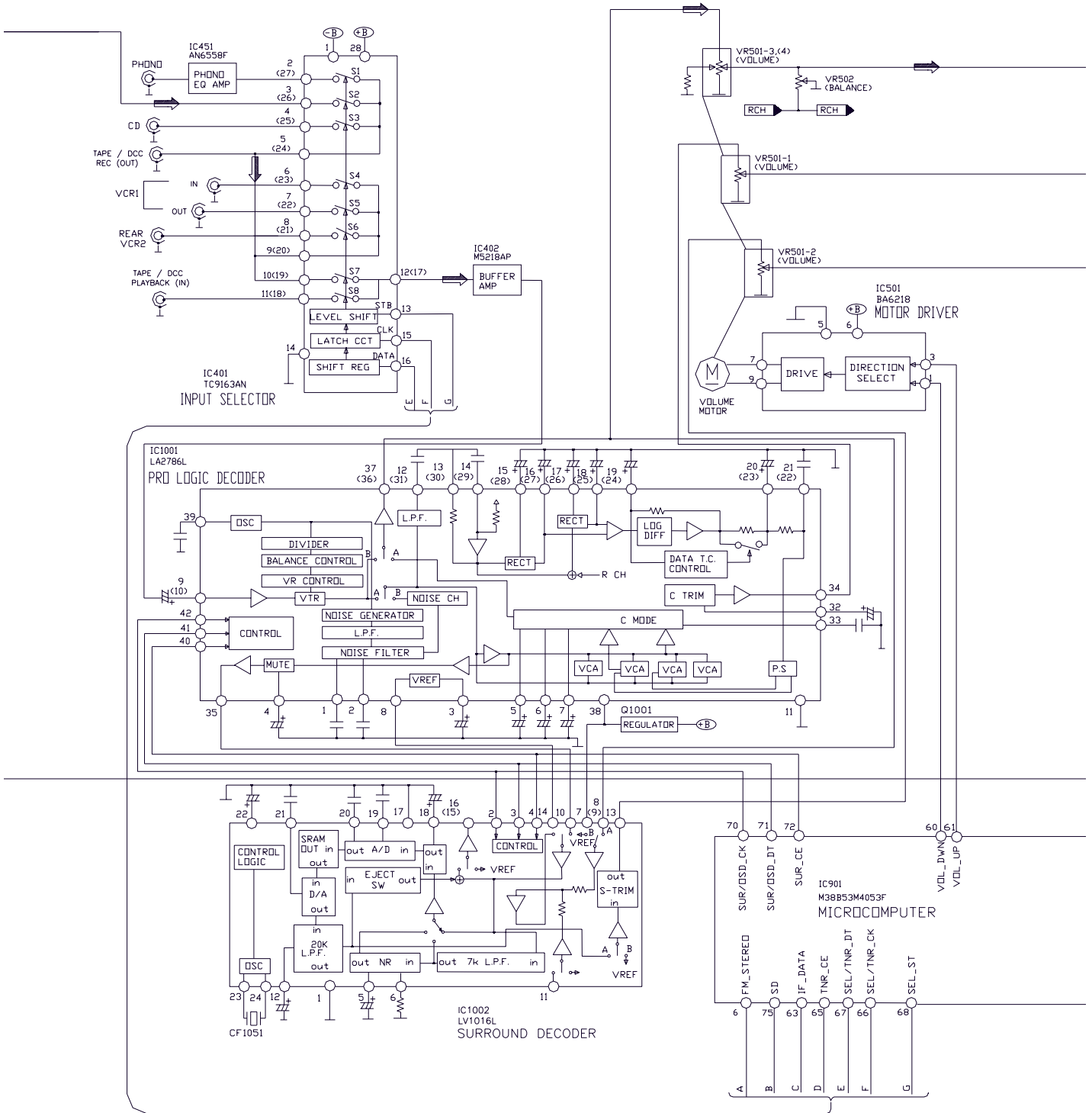

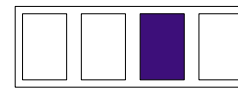
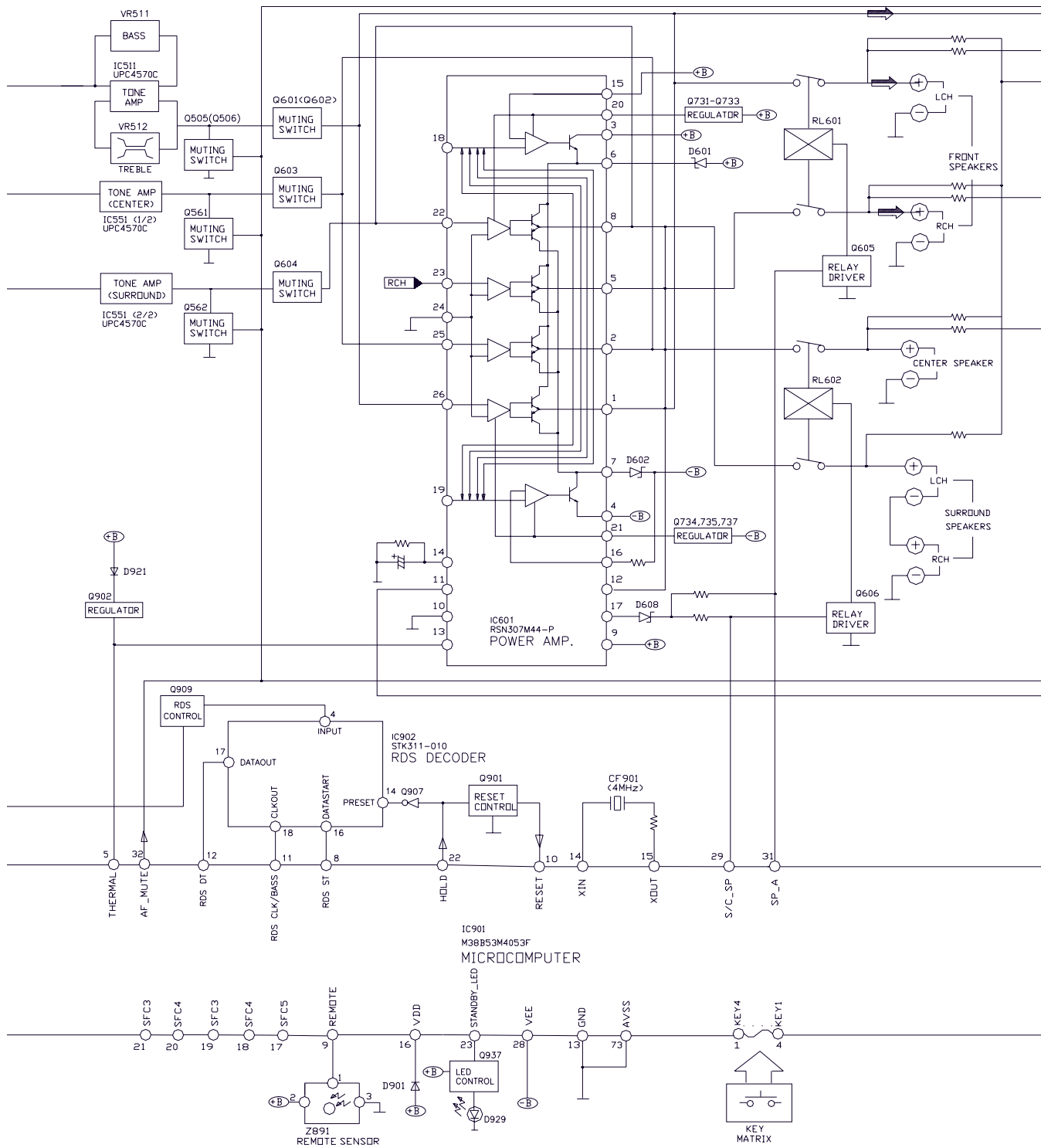

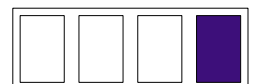
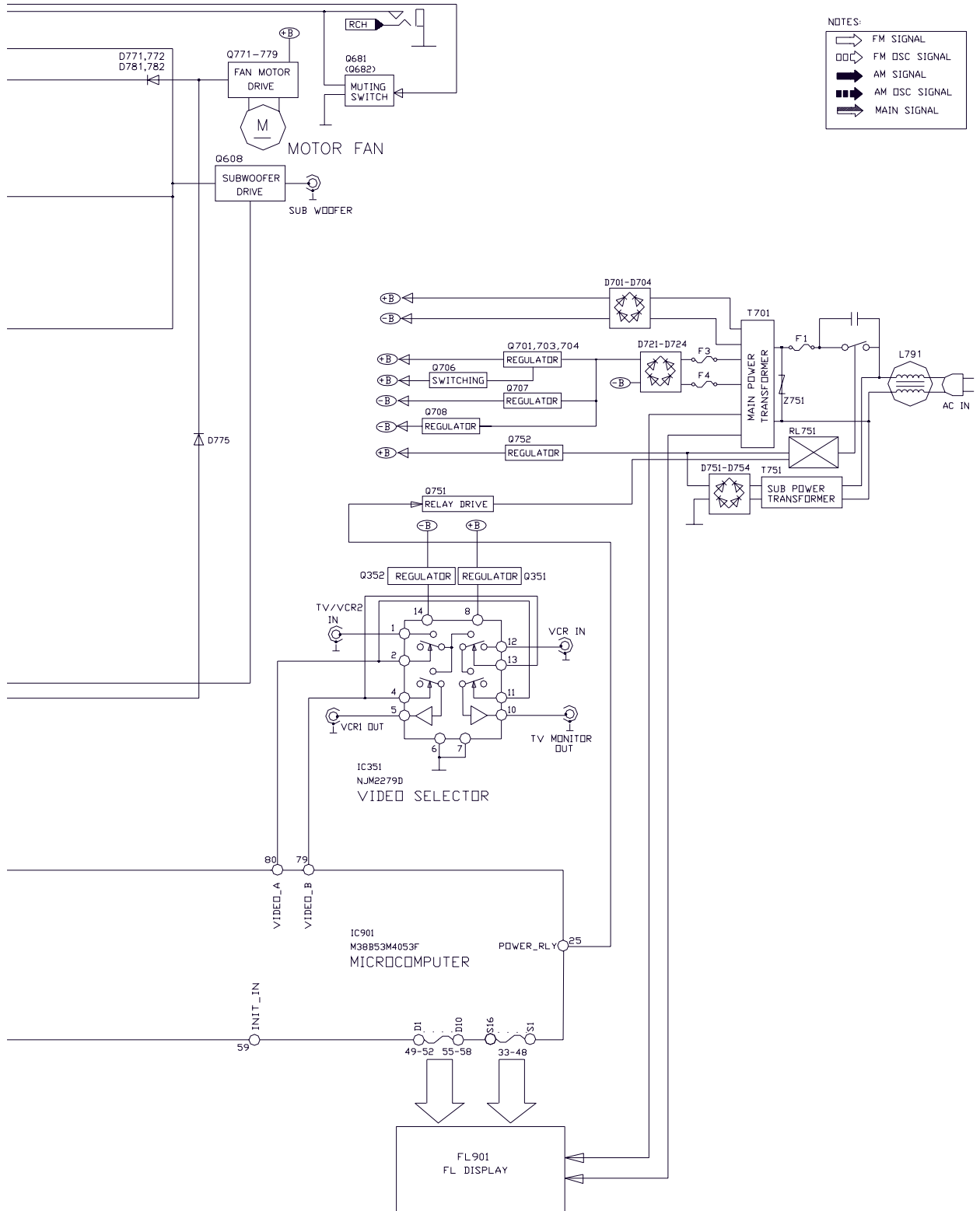

Terminal Functions Of ICs

• IC901 (M38B53M4053F) System Microprocessor

Pin No.	Mark	I/O	Function
1~4	KEY4~KEY1	I	Key matrix detect terminal
5	THERMOLD	I	Thermal/Over load detect terminal
6	FM_ST	I	Stereo signal detect terminal
7	6CH_ST	-	Not used
8	RDS_ST	-	Not used
9	REMOTE	I	Remote control terminal
10	RESET	I	Reset detect terminal
11	RDS_CK	-	Not used
12	RDS_DT	-	Not used
13	GND	-	GND terminal
14	XIN	I	Crystal oscillator terminal
15	XOUT	O	(4 MHz)
16	VDD	I	Power supply terminal
17~21	SFC5~SFC1	O	SFC LED indicator output
22	HOLD	I	Power trip detection input
23	STANDBY_LED	-	Not used
24	FAN_STOP	-	Not used
25	RLY	O	Power relay control output
26	TV/DVD	I	TV/DVD select control input
27	LIMITTER	O	Power limiter control output
28	VEE	I	FL driver pull down voltage
29	S/C_SP	O	Surround/center speaker control output
30	SP_B	O	Speaker B control output
31	SP_A	O	Speaker A control output
32	AF_MUTE	O	Muting control output

Pin No.	Mark	I/O	Function
33~48	SEG16~SEG1	O	FL segment signal output
49~58	DEG1~DEG10	O	FL digit signal output
59	INIT_IN	I	Diode input
60	VOL_DOWN	O	Rotate control terminal of volume motor
61	VOL_UP	O	
62	LOUDNESS	-	Not used
63	IF_DATA	I	Serial data signal
64	REC_MUTE	-	Not used
65	TNR_CE	O	Chip enable signal
66	SEL/TNR_CK	O	Serial clock signal
67	SEL/TNR_DT	O	Serial data signal
68	SEL_ST	O	Level shift control terminal
69	OSD_ST	-	Not used
70	SURROSD_CK	O	Serial clock signal
71	SURROSD_DT	O	Serial data signal
72	SURR_CE	O	Chip enable signal
73	AVSS	-	GND for A-D conveter
74	VREF	I	Reference voltage for A-D conversion
75	SD	I	SD signal detect input
76	AC3_LED	-	Not used
77	HELP_LED	O	LED drive signal (HELP)
78	VIDEO_DET	-	Not used
79	VIDEO_B	O	Video selector control output B
80	VIDEO_A	O	Video selector control output A

Terminal Guide of ICs, Transistors and Diodes

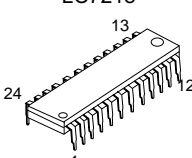
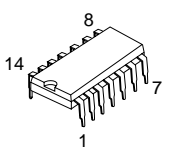
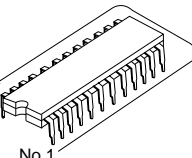
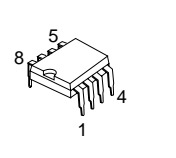
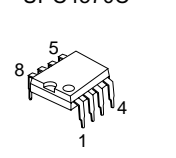
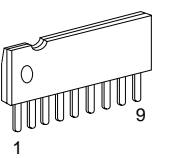
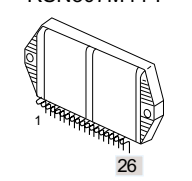
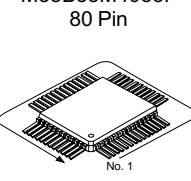
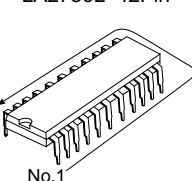
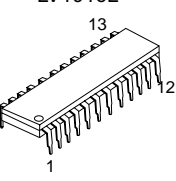
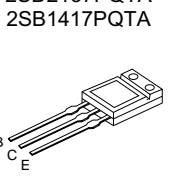
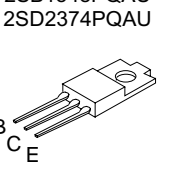
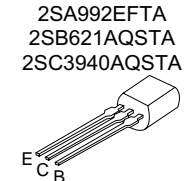
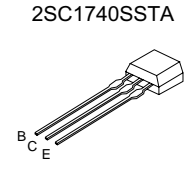
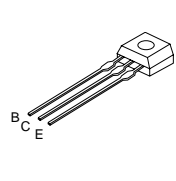
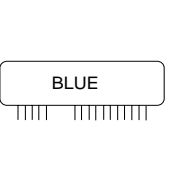
<p>LA1832A LC7218</p> 	<p>NJM2279D</p> 	<p>TC9163AN 28Pin</p> 	<p>M5218P</p> 	<p>AN6558F UPC4570C</p> 	<p>BA6218</p> 
<p>RSN307M44-P</p> 	<p>M38B53M4053F 80 Pin</p> 	<p>LA2786L 42Pin</p> 	<p>LV1016L</p> 	<p>2SD2137PQTA 2SB1417PQTA</p> 	<p>2SB1548PQAU 2SD2374PQAU</p> 
<p>2SD592AQSTA 2SA992EFTA 2SB621AQSTA 2SC3940AQSTA</p> 	<p>2SA933SSTA 2SC1740SSTA</p> 	<p>RVTDTA113ZST RVTDTA114EST RVTDTTC143XST RVTDTA143XST RVTDTTC114YST RVTDTA114YST RVTDTA114EST</p>		<p>2SC2787LTA 2SC2785FETA 2SC3311ARTA 2SD1915FTA</p>	<p>STK311-010</p> 

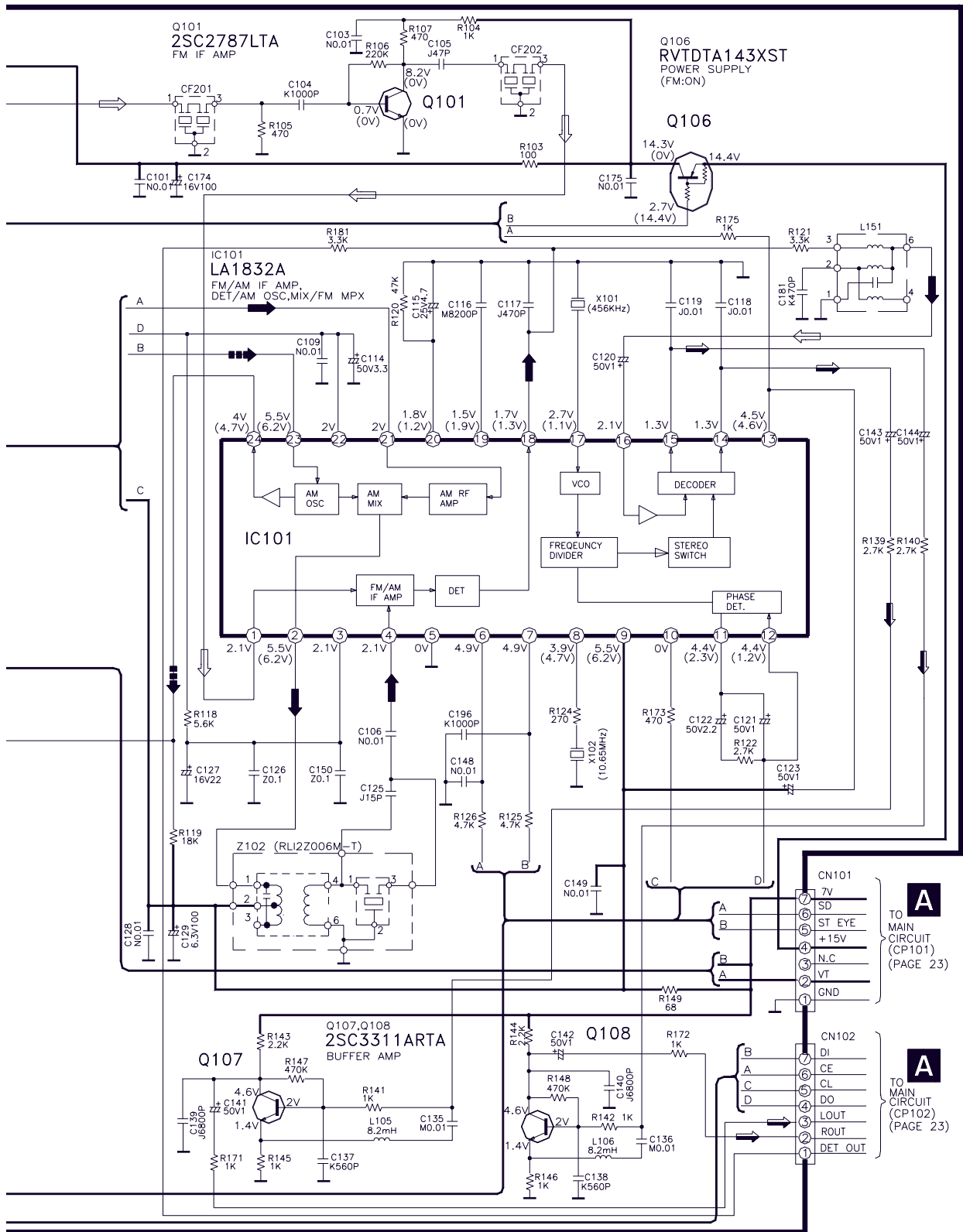

A
TO MAIN
CIRCUIT
(CP101)
(PAGE 23)

A
TO MAIN
CIRCUIT
(CP102)
(PAGE 23)



A MAIN CIRCUIT

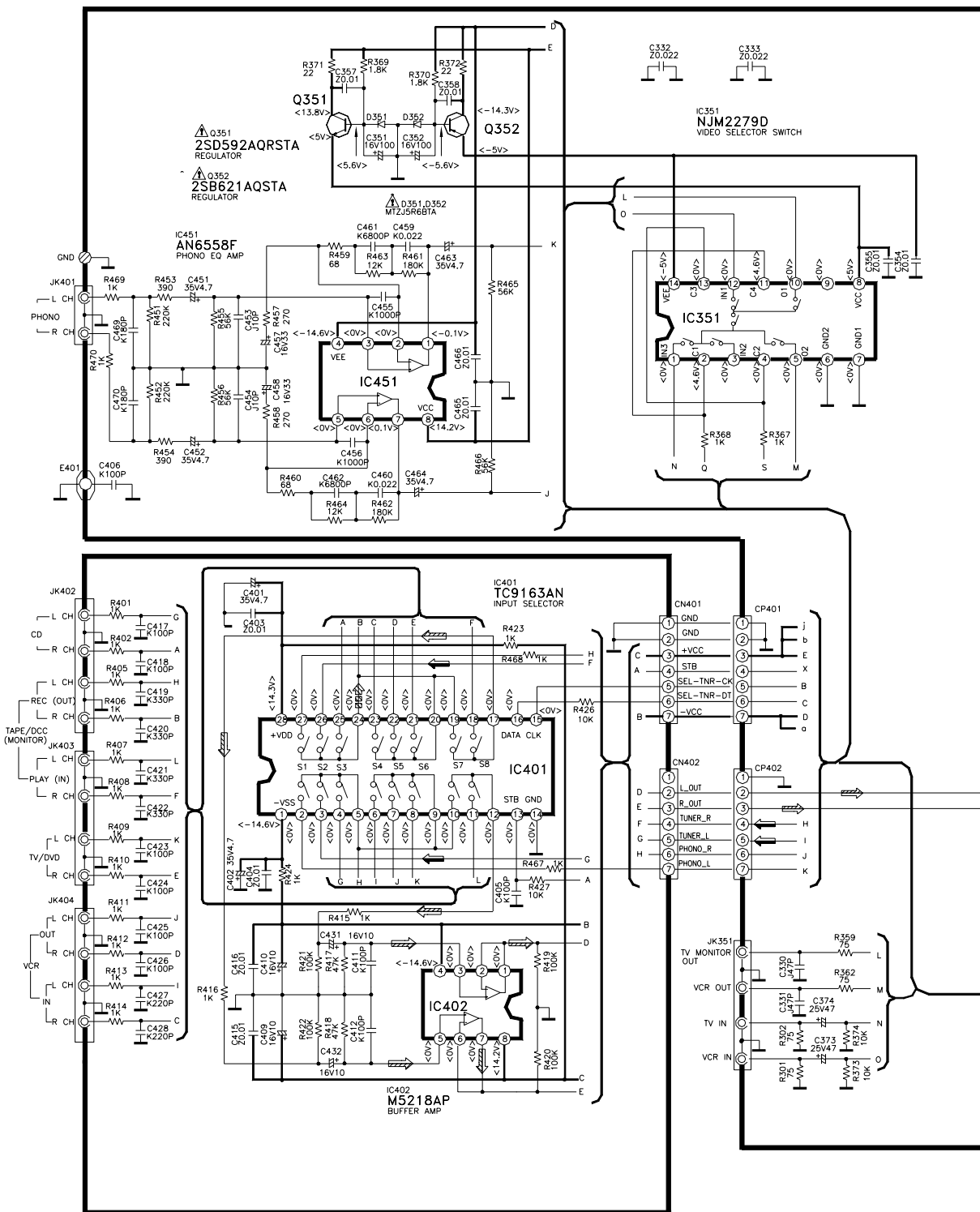

G IN/OUT TERMINAL CIRCUIT

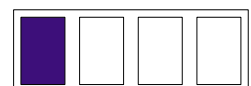

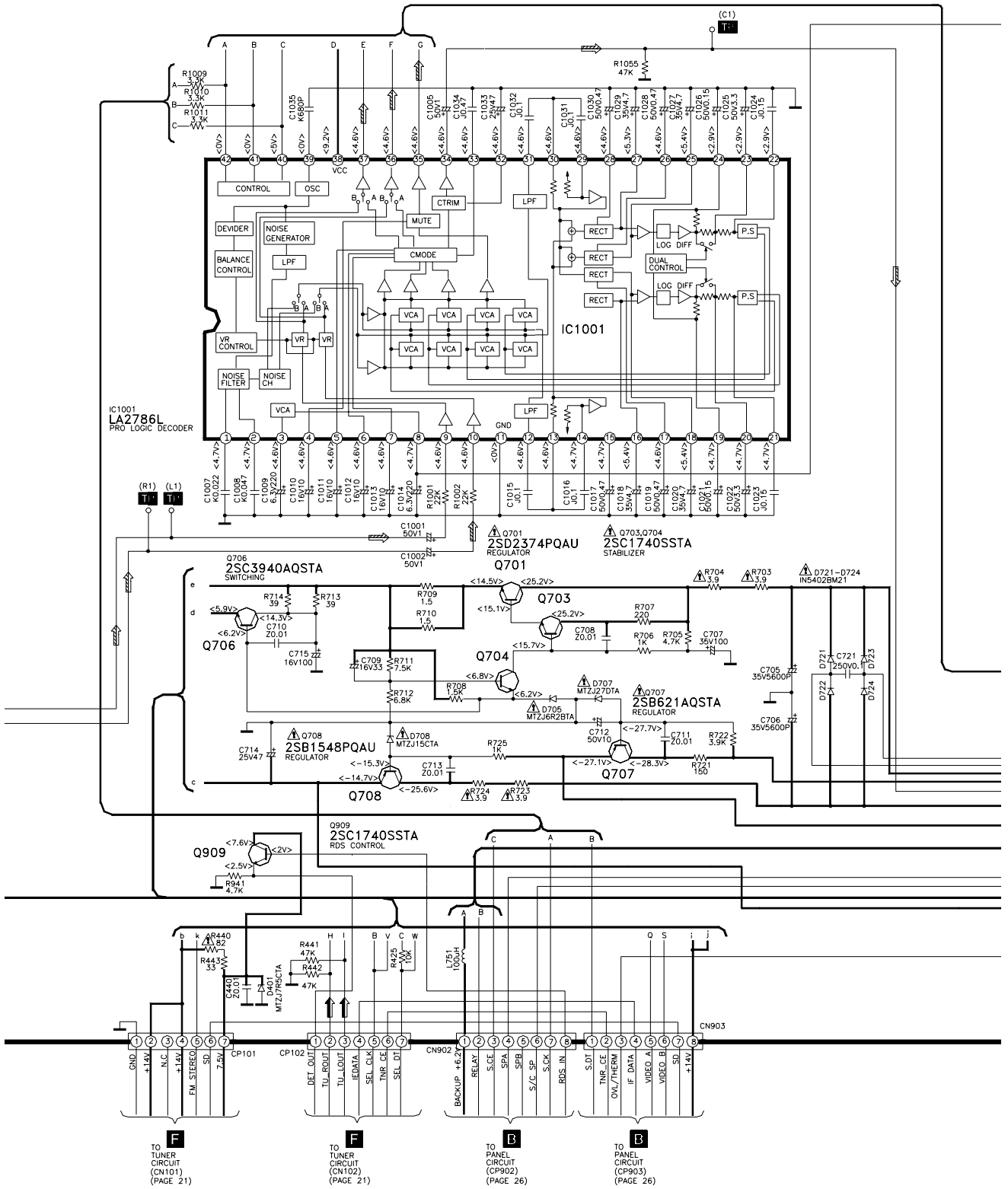

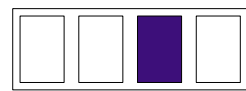
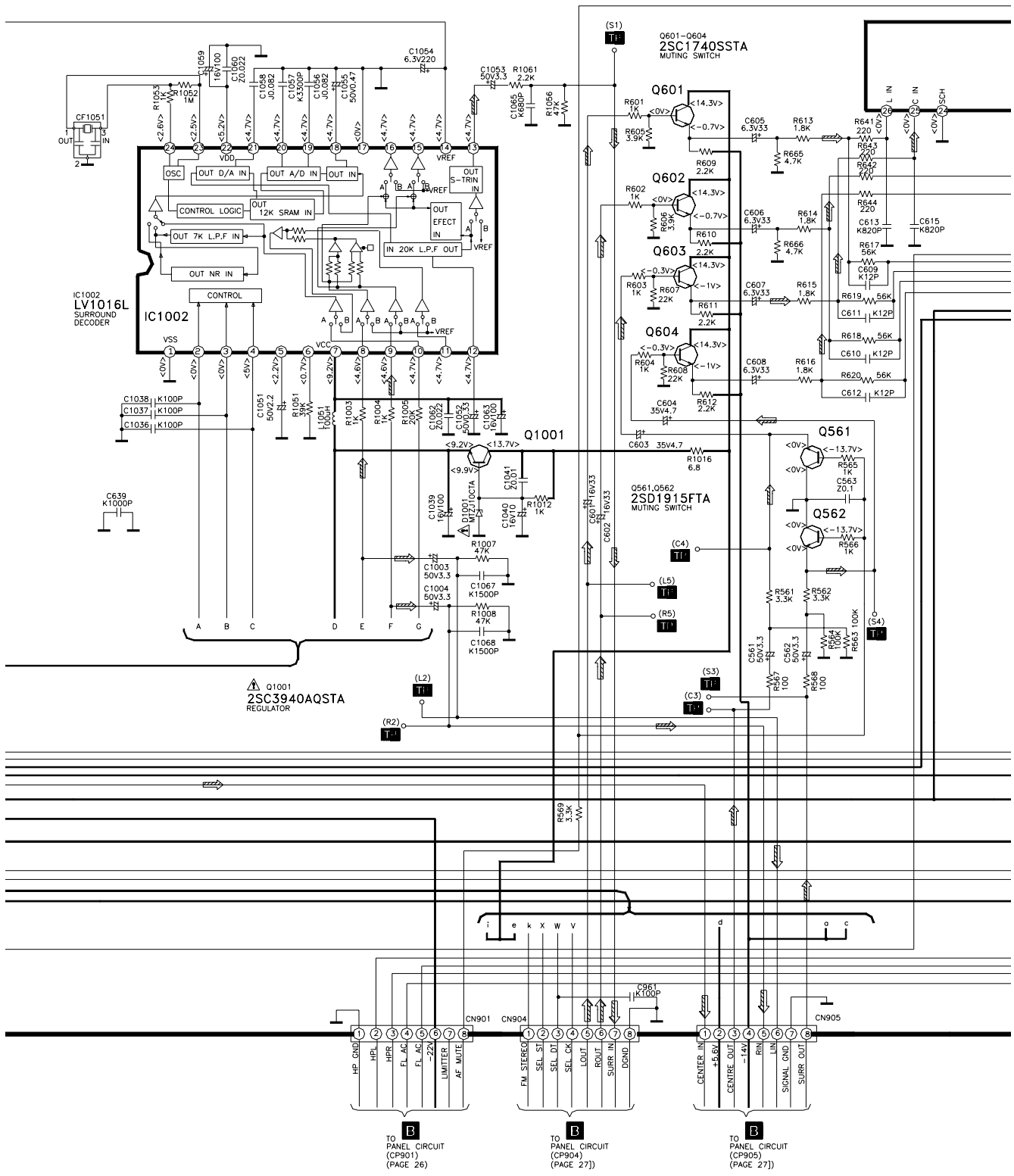

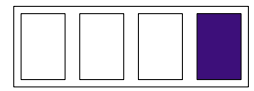
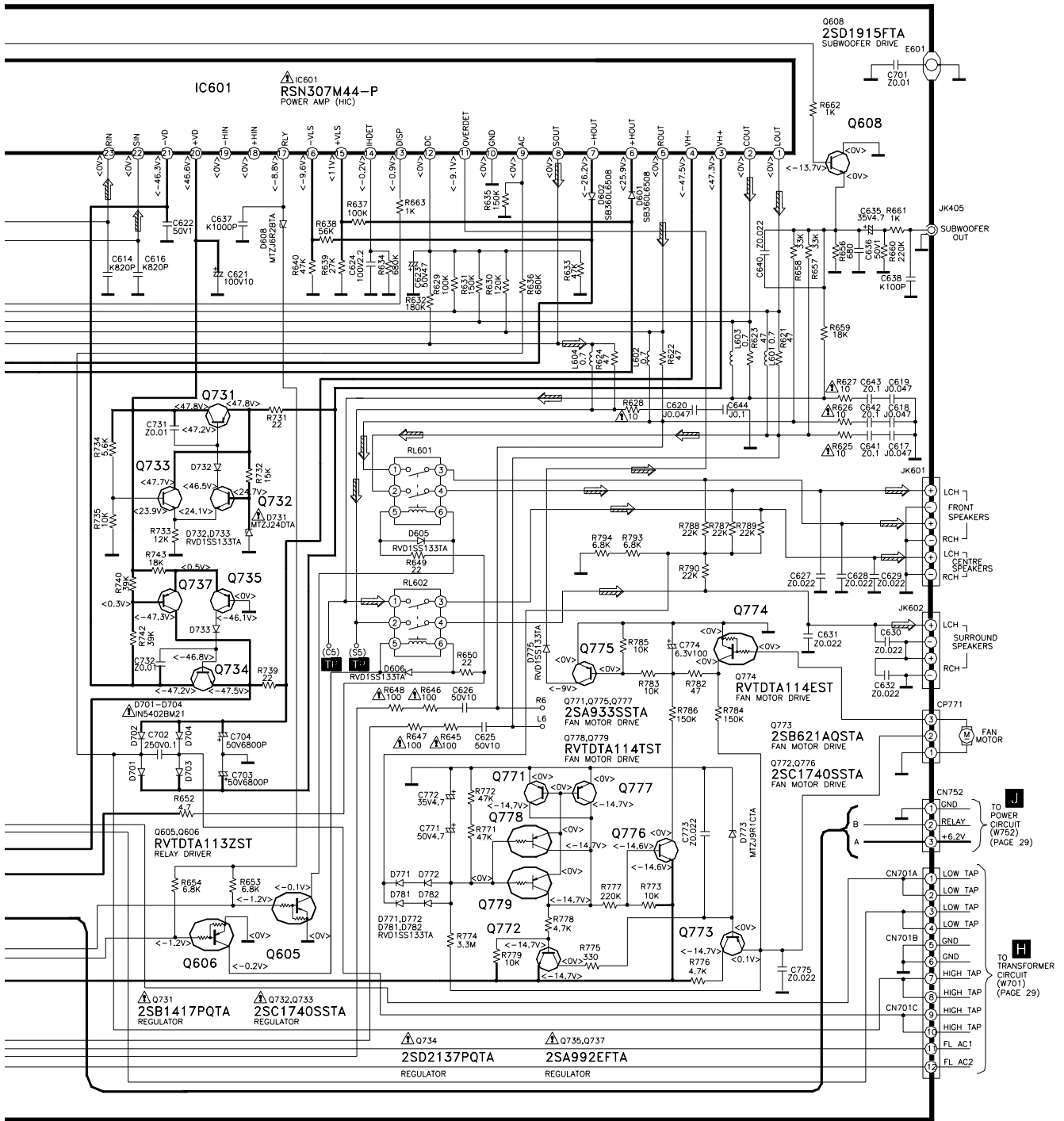

B PANEL CIRCUIT

A
TO MAIN
CIRCUIT
(CN901)
(PAGE 24)

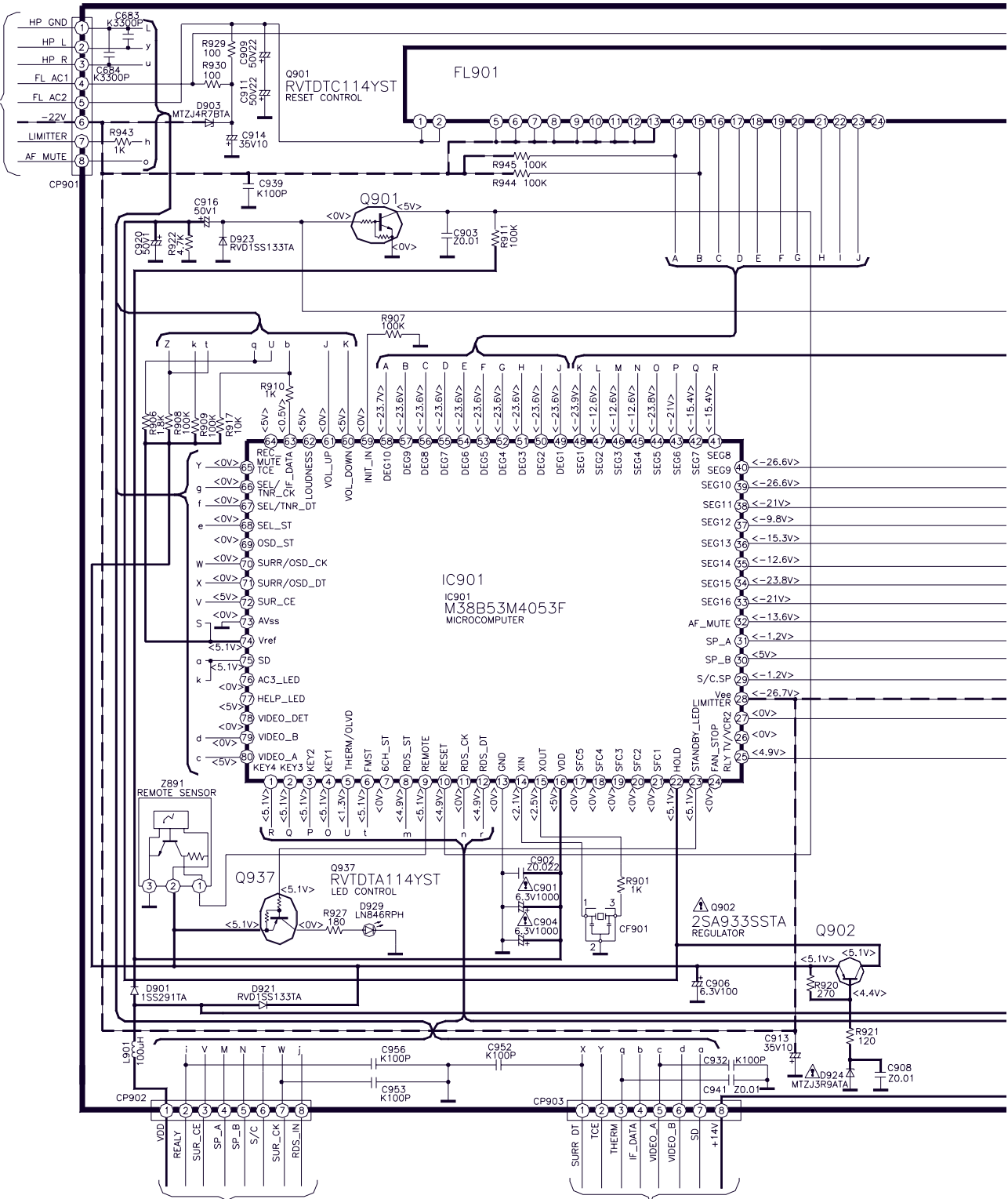

A
TO MAIN
CIRCUIT
(CN902)
(PAGE 23)

A
TO MAIN
CIRCUIT
(CN903)
(PAGE 23)

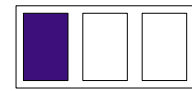

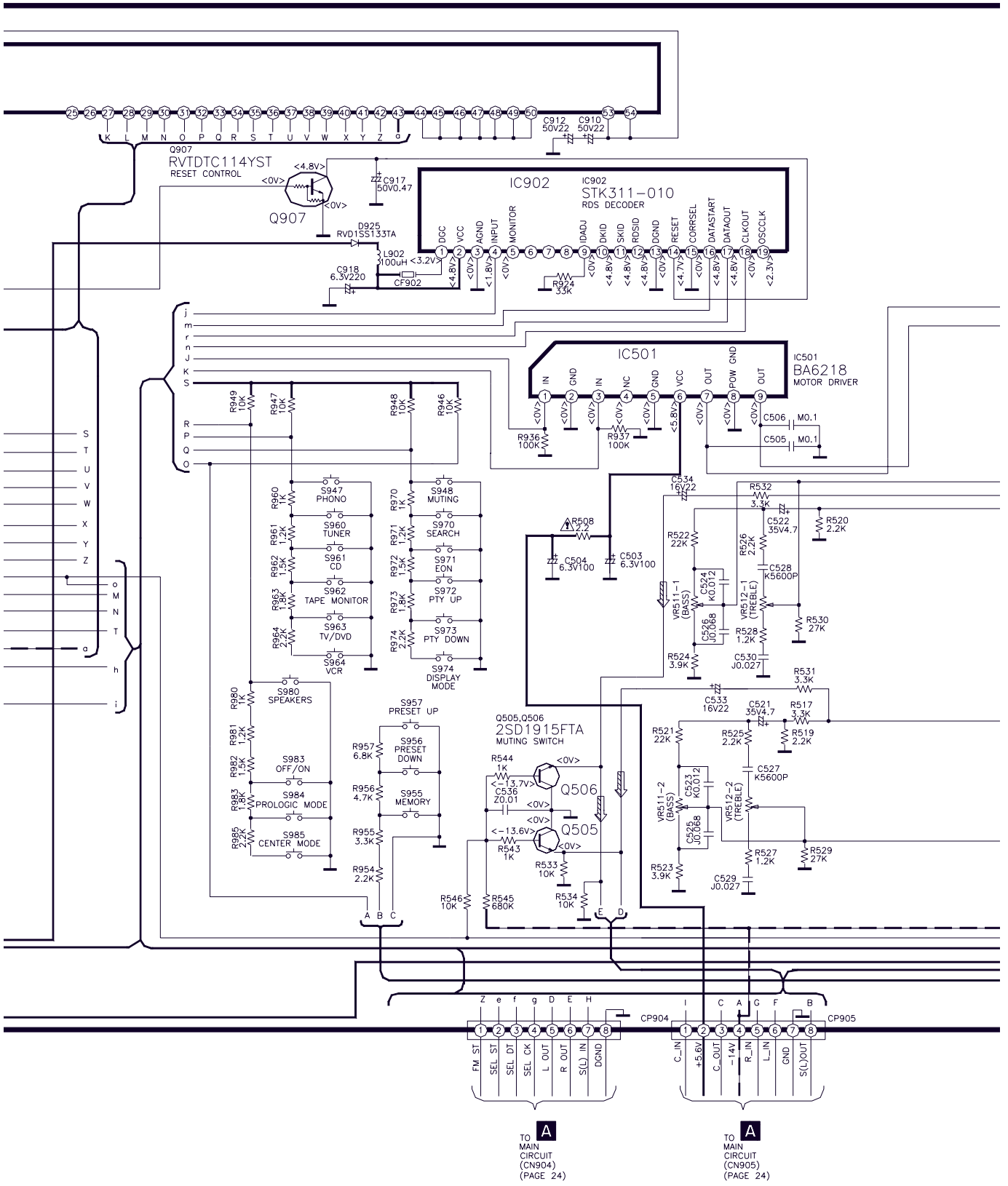

TO MAIN CIRCUIT (CN904) (PAGE 24)

TO MAIN CIRCUIT (CN905) (PAGE 24)

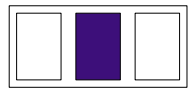

C MOTOR CIRCUIT

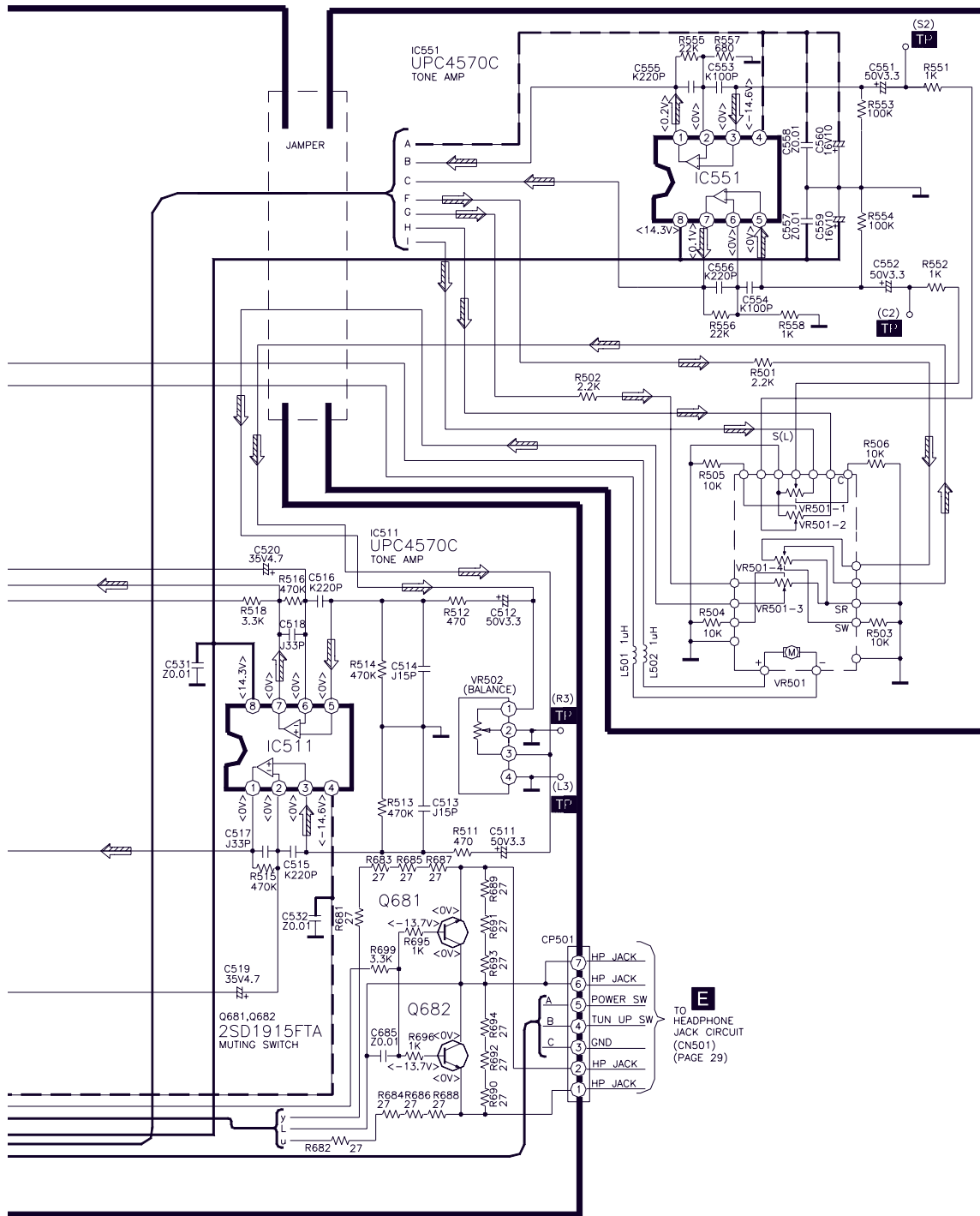

E
TO HEADPHONE JACK CIRCUIT (CN501) (PAGE 29)

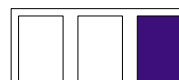

E HEADPHONE JACK CIRCUIT

D POWER SWITCH CIRCUIT

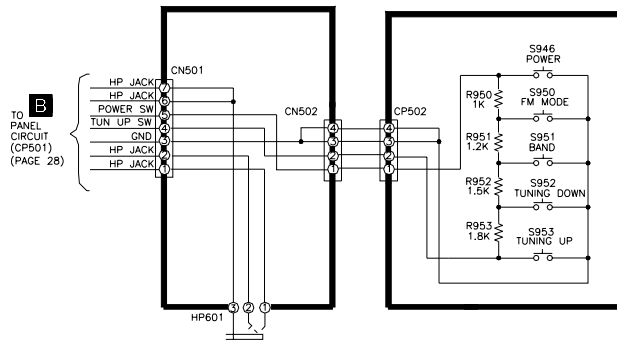

J POWER CIRCUIT

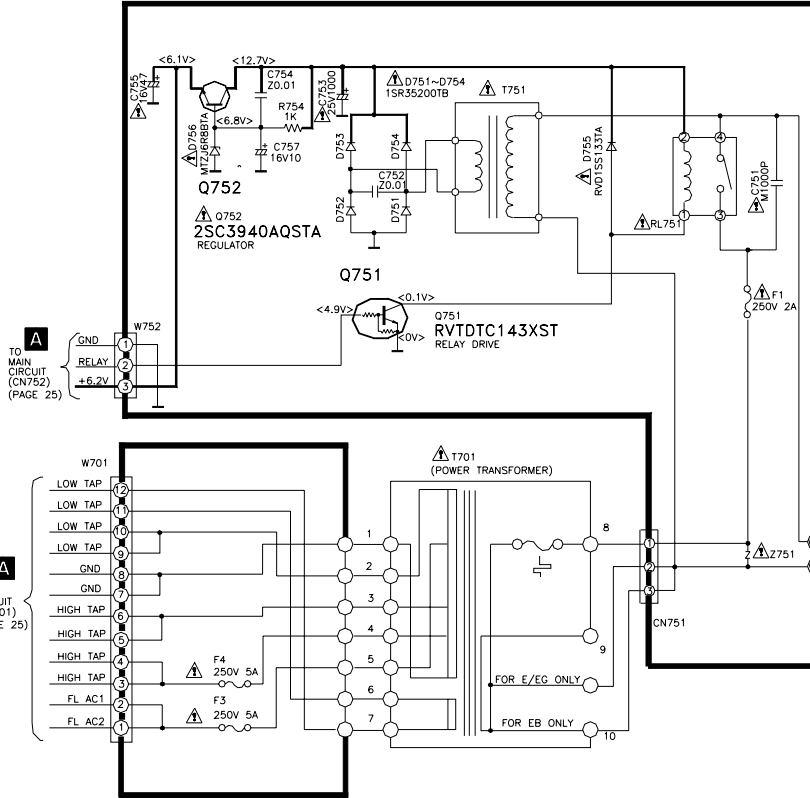

K AC IN/OUT CIRCUIT

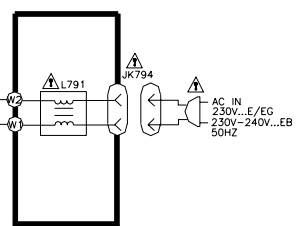

H TRANSFORMER CIRCUIT

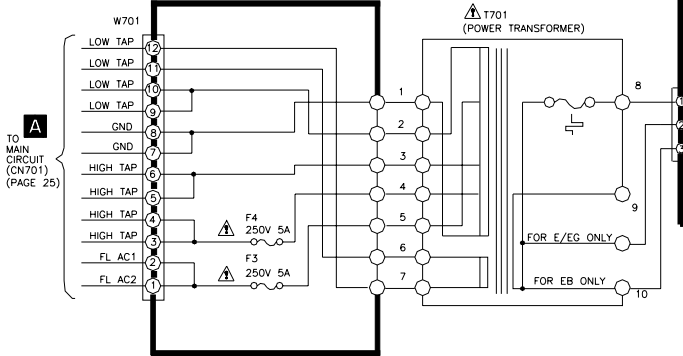

■ Printed Circuit Board

■ MOTOR P.C.B. (REP2445D-S)

■ PANEL P.C.B. (REP2445D-S)

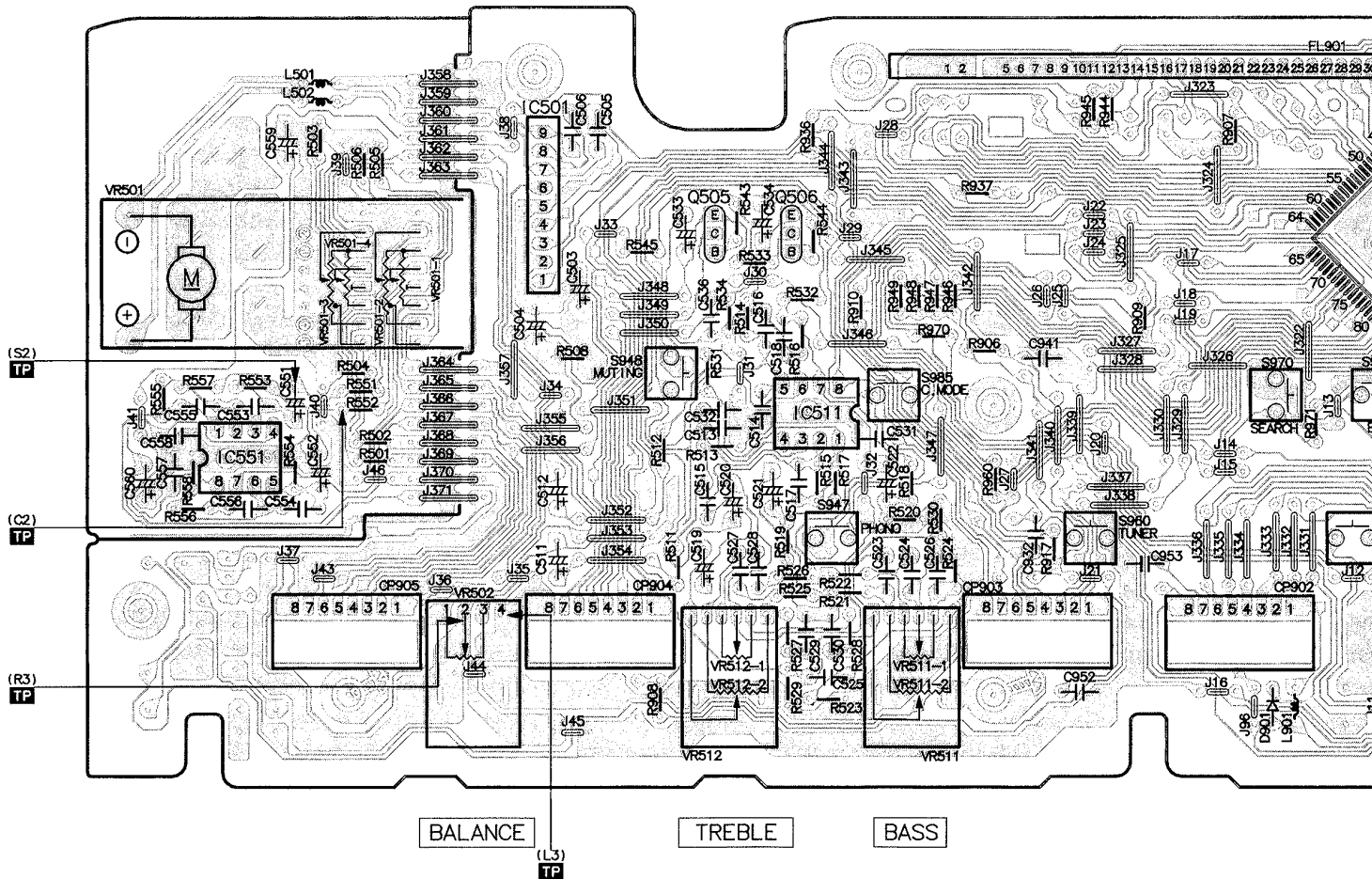

■ HEADPHONE JACK P.C.B. (REP2445D-S)

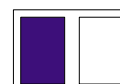
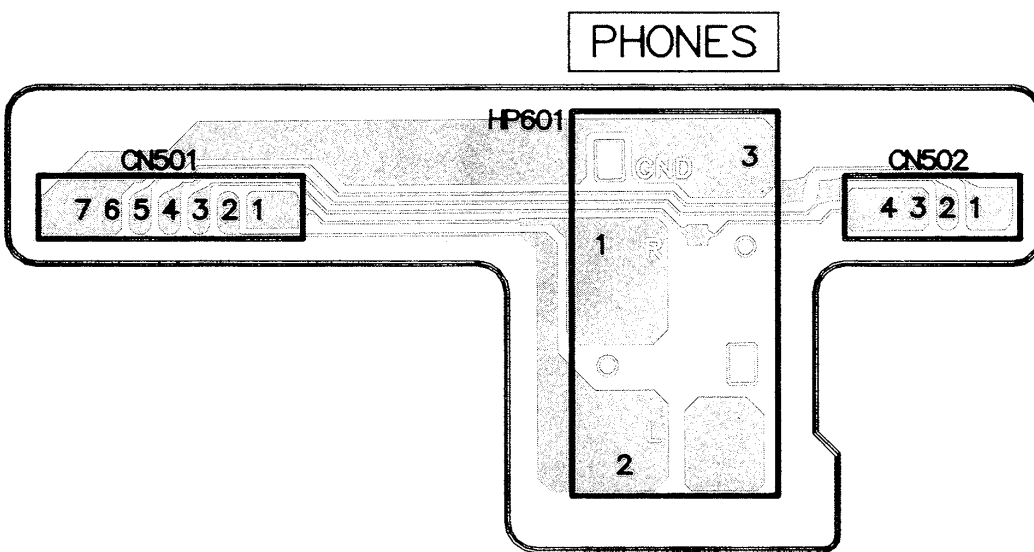

SENSOR

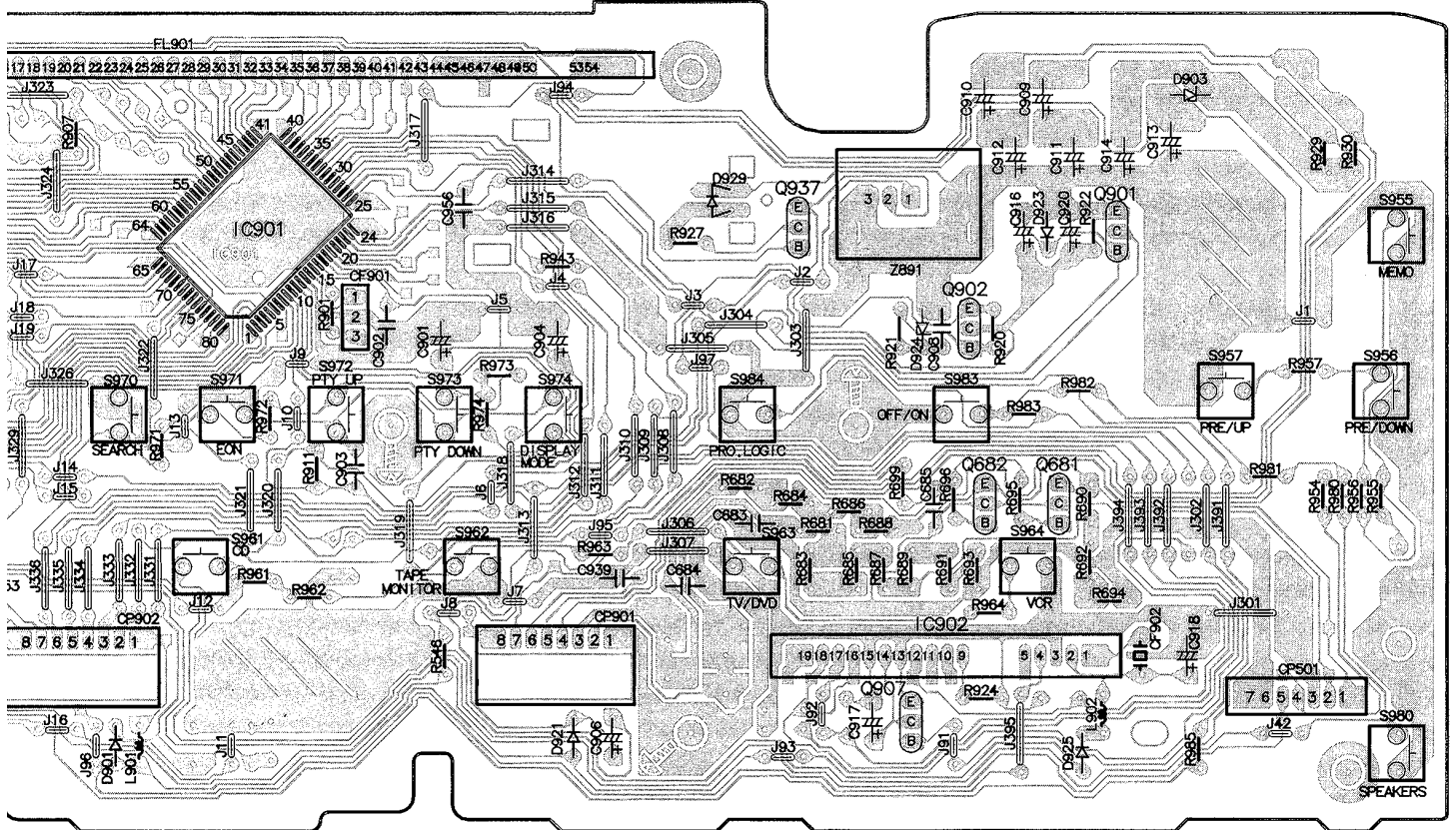

D POWER SWITCH P.C.B. (REP2445D-S)

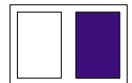
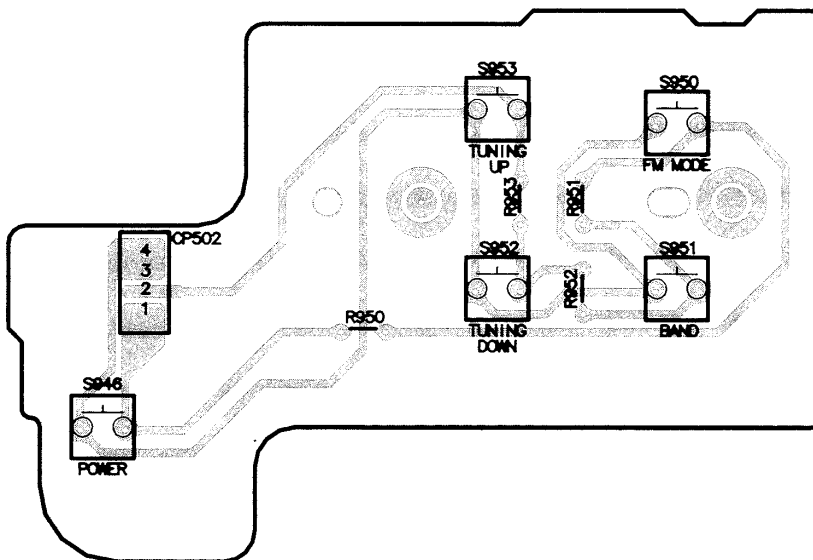

MAIN P.C.B. (REP2444C-M)

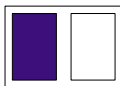
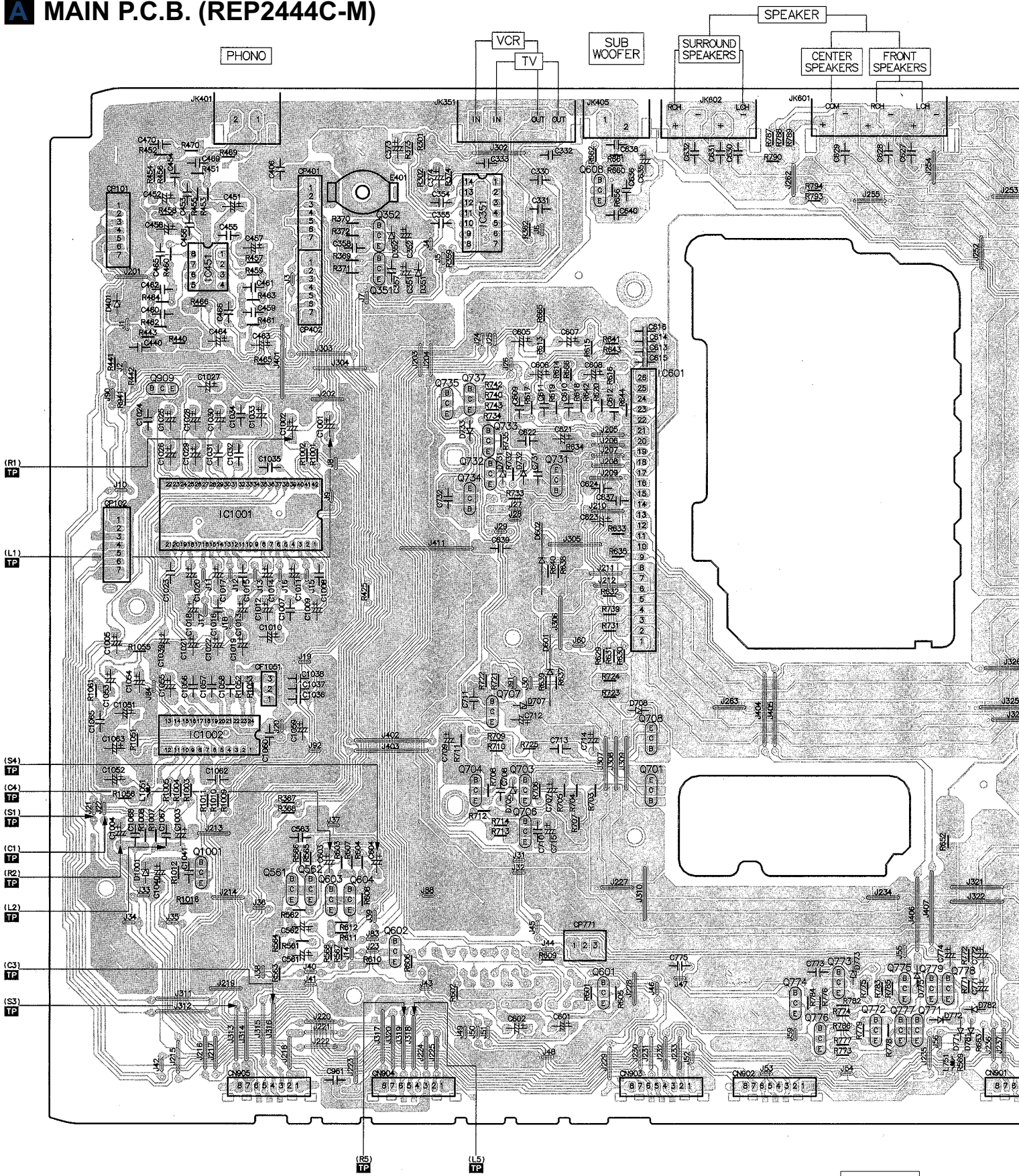

F TUNER P.C.B. (REP2158A-T).....EG
(REP2158D-T).....E/EB

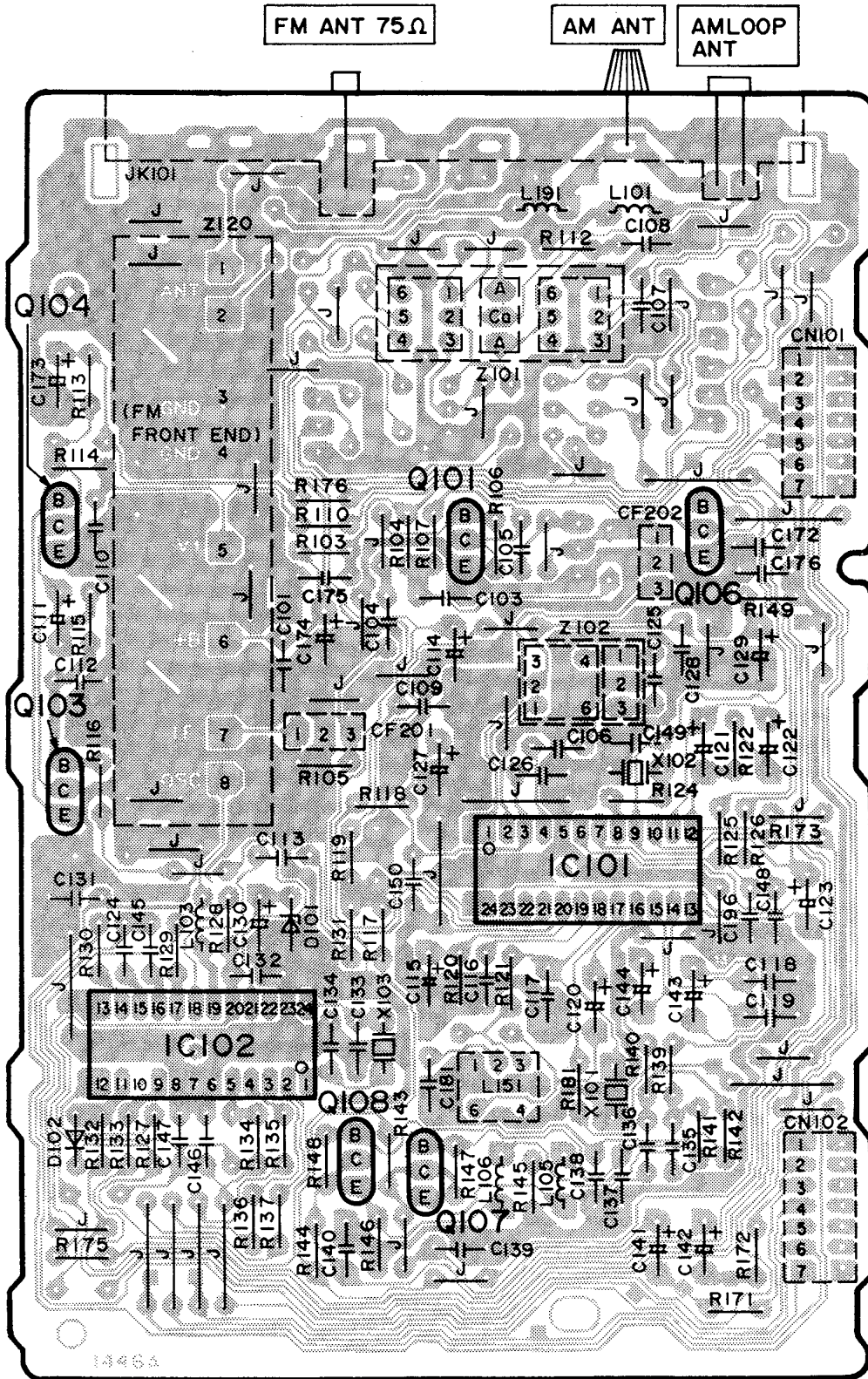

H TRANSFORMER P.C.B.
(REP2444C-M)

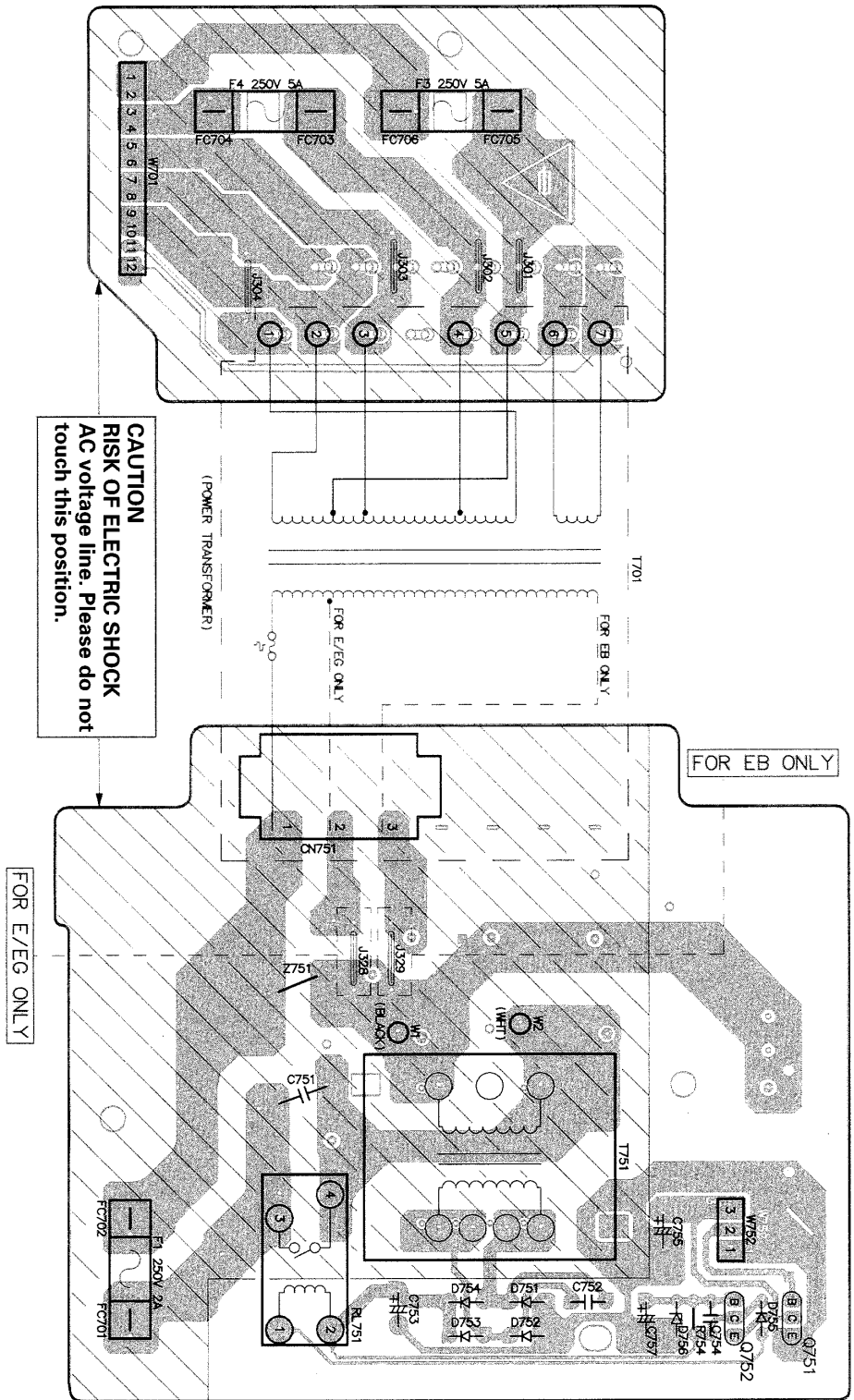

POWER P.C.B.
(REP2446D-P).....E/EG
(REP2446E-P).....EB

IN / OUT TERMINAL P.C.B.
 (REP2446D-P).....E/EG
 (REP2446E-P).....EB

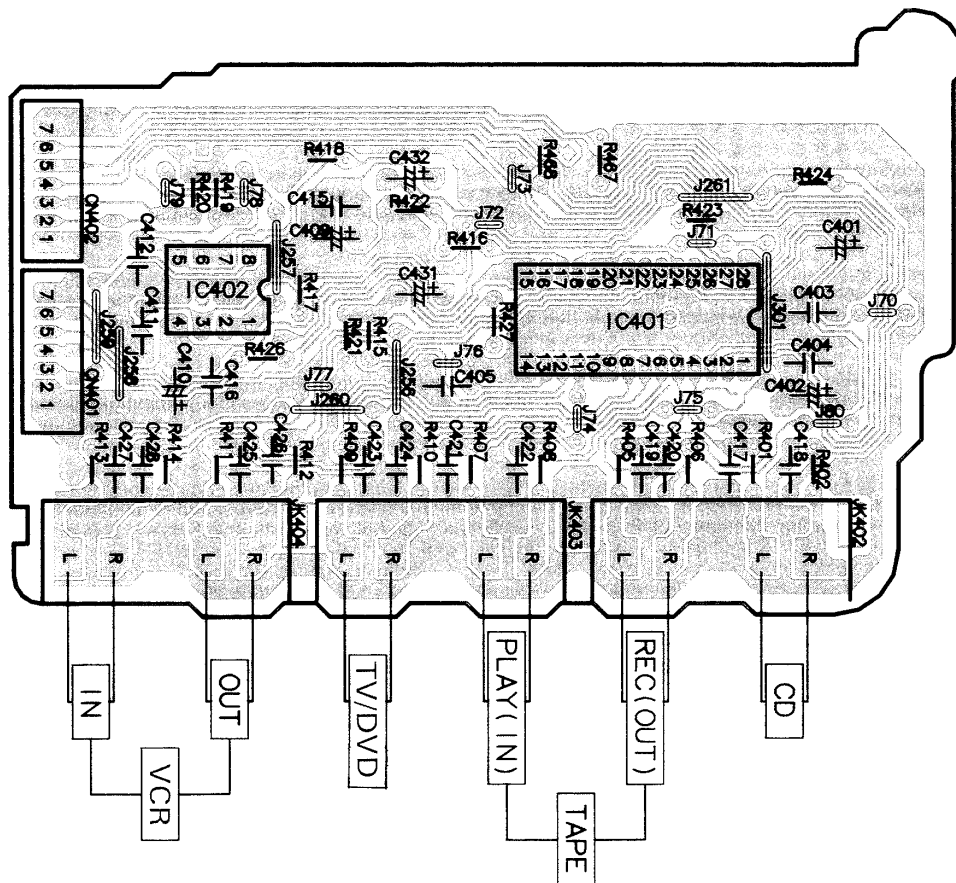

AC IN/OUT P.C.B.
 (REP2446D-P).....E/EG
 (REP2446E-P).....EB

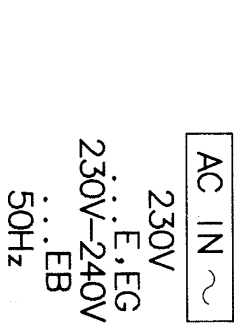

CAUTION
RISK OF ELECTRIC SHOCK
 AC voltage line. Please do not touch this portion.

Wiring Connection Diagram

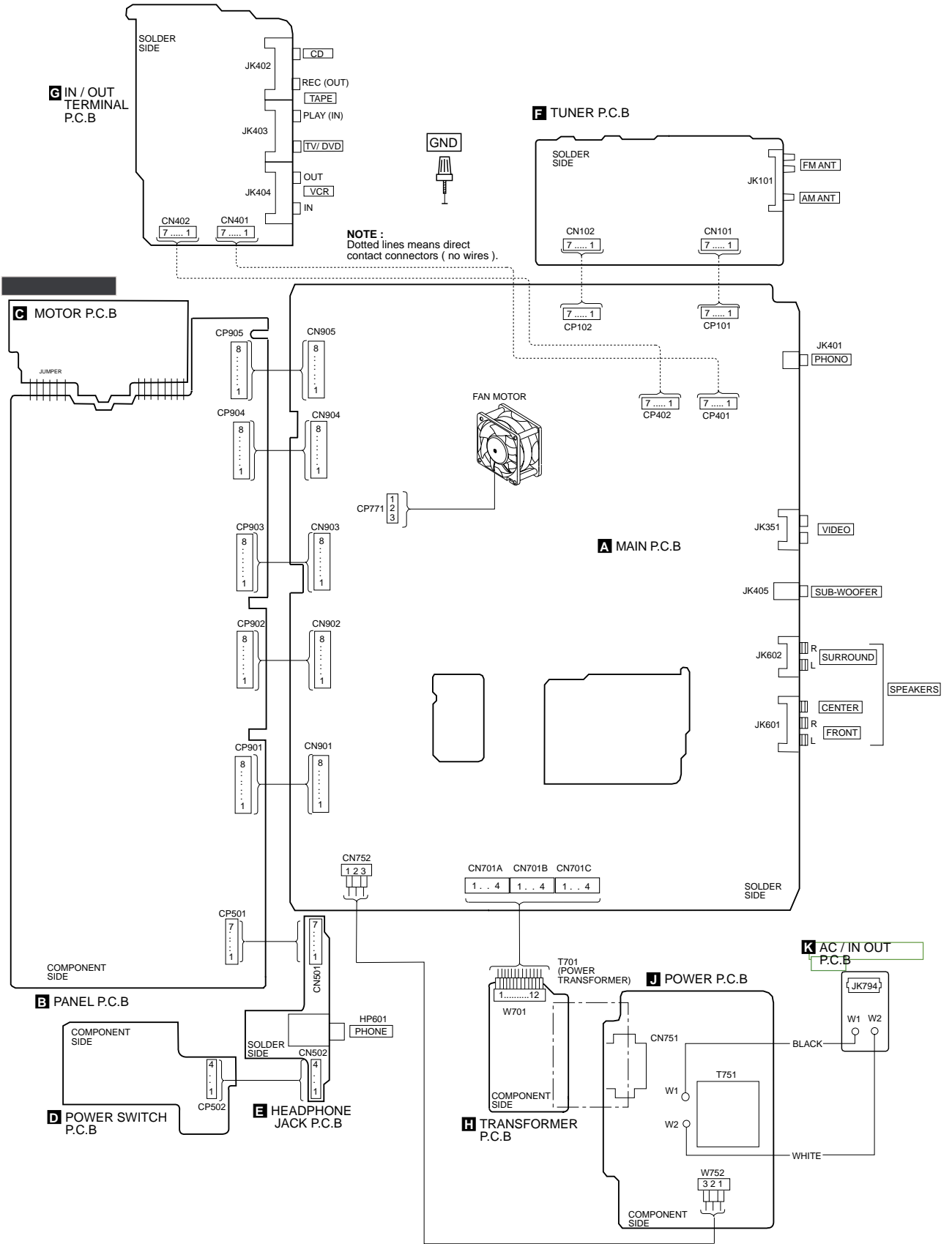

■ Cabinet Parts Location

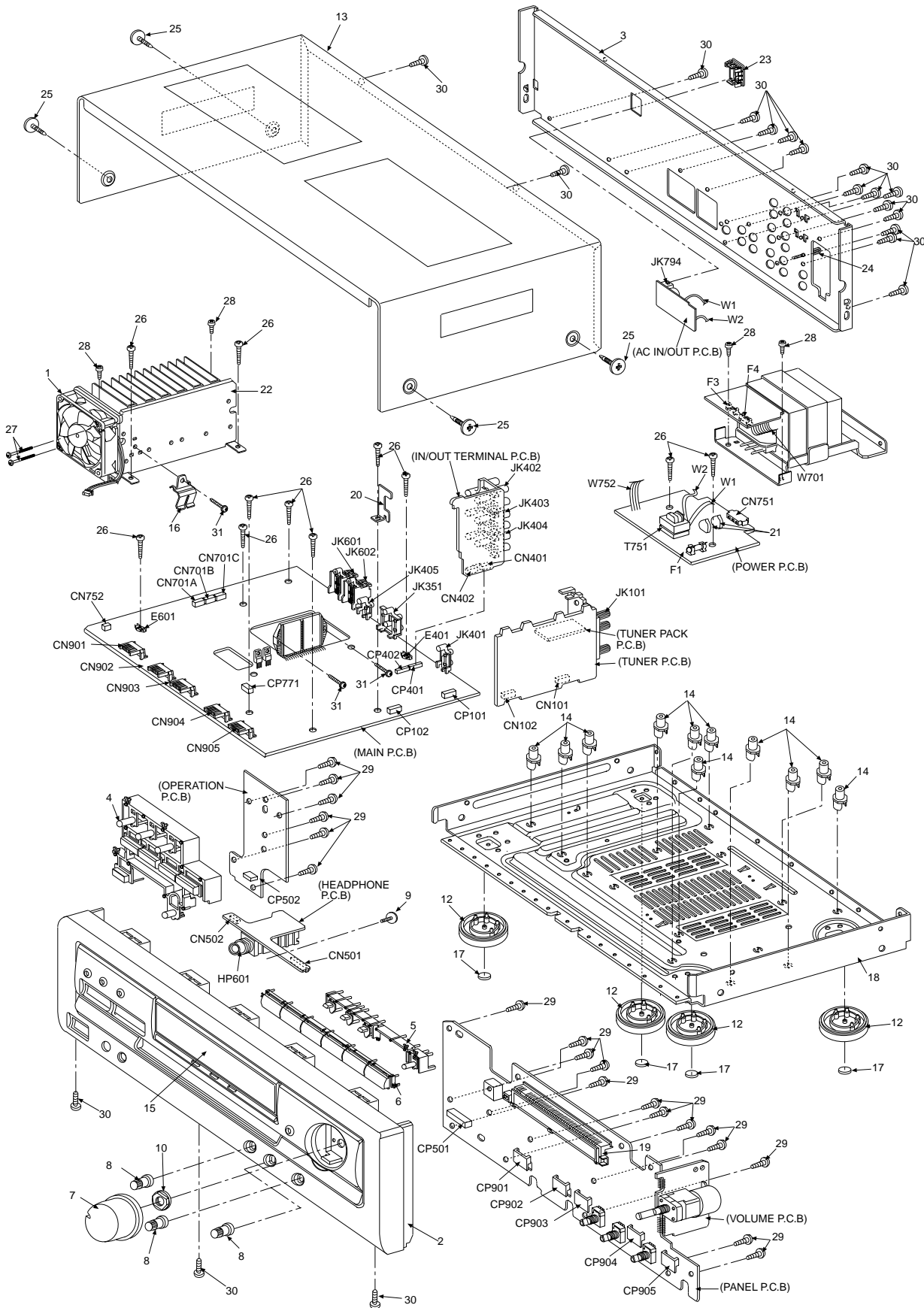

■ Replacement Parts List

Notes: * Important safety notice :

 Components identified by  mark have special characteristics important for safety.

Furthermore, special parts which have purposes of fire-retardant (resistors), high-quality sound (capacitors), low-noise (resistors), etc. are used. When replacing any of components, be sure to use only manufacturer's specified parts shown in the parts list.























* The parenthesized in the Remarks columns specify the areas. (Refer to the cover page for area.)























Parts without these indication can be used for all areas.

 * [M] in Remarks column indicates parts that are supplied by **MESA**.

* Remote Control Unit : Supply period for three years from terminal of production.

* The "(SF)" mark denotes the standard part.

Ref No.	Part No.	Part Name & Description	Remarks	Ref No.	Part No.	Part Name & Description	Remarks	Ref No.	Part No.	Part Name & Description	Remarks
		CABINETANDCHASSIS		IC402	M5218AP	IC, BUFFER AMP	[M]	Q731	2SB147PQ1A	TRANSISTOR	 [M]
				IC451	AN6558F	IC, OP AMP	[M]	Q732	2SC1740SSTA	TRANSISTOR	 [M]
1	REM0069	FAN UNIT	[M]	IC501	BA6218	IC, MOTOR DRIVER	[M]	Q733	2SC1740SSTA	TRANSISTOR	 [M]
2	RFK6EX310EK	FRONT PANEL ASSY	[M]	IC511	UPC4570C	IC, TONE CONTROL	[M]	Q734	2SD2137PQ1A	TRANSISTOR	 [M]
3	RGR0251B-A	REAR PANEL	[ME] E	IC551	UPC4570C	IC, TONE CONTROL	[M]	Q735	2SA982EFT1A	TRANSISTOR	 [M]
3	RGR0251B-B	REAR PANEL	[ME] B	IC601	RSN307M44-P	IC, HIC	 [M]	Q737	2SA982EFT1A	TRANSISTOR	 [M]
4	RGU1350-K	MODE BUTTON	[M]	IC901	M38B53M4053F	IC, MICOM	[M]	Q751	R/1DTC143ST	TRANSISTOR	[M]
5	RGU1352MK	DOLBY BUTTON	[M]	IC902	STK311-010	IC, RDS DECODER	[M]	Q752	2SC3940QSTA	TRANSISTOR	 [M]
6	RGU1493-K	SELECTOR BUTTON	[M]	IC1001	LA2786L	IC, DPL	[M]	Q771	2SA983SSTA	TRANSISTOR	[M]
7	RGW0243A-K	VOLUME KNOB	[M]	IC1002	LV1016L	IC, SURR DECODER	[M]	Q772	2SC1740SSTA	TRANSISTOR	[M]
8	RGW0244K1	BASS TREBLE KNOB	[M]					Q773	2SB621AQSTA	TRANSISTOR	[M]
9	RHD26016	SCREW	[M]			TRANSISTORS		Q774	R/1DTA114EST	TRANSISTOR	[M]
10	RH-N90001	M9 NUT	[M]	Q101	2SC2787LTA	TRANSISTOR	[M]	Q775	2SA983SSTA	TRANSISTOR	[M]
12	RKA0079-A	LEG	[M]	Q103	2SC2788FETA	TRANSISTOR	[M]	Q776	2SC1740SSTA	TRANSISTOR	[M]
13	RKM0260D-K	TOP CABINET	[ME] E	Q104	2SC2788FETA	TRANSISTOR	[M]	Q777	2SA983SSTA	TRANSISTOR	[M]
14	RKQ0089-J	PCB HOLDER	[M]	Q106	R/1DTA143ST	TRANSISTOR	[M]	Q778	R/1DTA1141ST	TRANSISTOR	[M]
15	RKM0436E-Q	FL WINDOW	[M]	Q107	2SC3311ART1A	TRANSISTOR	[M]	Q779	R/1DTA1141ST	TRANSISTOR	[M]
16	RMC0158-S	TRANSISTOR HOLDER	[M]	Q108	2SC3311ART1A	TRANSISTOR	[M]	Q801	R/1DTC114YST	TRANSISTOR	[M]
17	RMG0270-K	LEG CUSHION	[M]	Q851	2SB621AQSTA	TRANSISTOR	 [M]	Q802	2SA983SSTA	TRANSISTOR	 [M]
18	RMK0350	BOTTOM CHASSIS	[M]	Q852	2SB621AQSTA	TRANSISTOR	 [M]	Q807	R/1DTC114YST	TRANSISTOR	[M]
19	RMN0372	FL HOLDER	[M]	Q855	2SD1915FTA	TRANSISTOR	[M]	Q809	2SC1740SSTA	TRANSISTOR	[M]
20	RMQ0709	TUNER PCB BRACKET	[M]	Q856	2SD1915FTA	TRANSISTOR	[M]	Q887	R/1DTA1141ST	TRANSISTOR	[M]
21	RMZ0339	ZNR COVER	[M]	Q851	2SD1915FTA	TRANSISTOR	[M]	Q10012S	2SC3940QSTA	TRANSISTOR	 [M]
22	RXX0186	HEAT SINK UNIT	[M]	Q852	2SD1915FTA	TRANSISTOR	[M]			DIODES	
23	SJS9231A	A/C INLET COVER	[M]	Q801	2SC1740SSTA	TRANSISTOR	[M]	D101	MIZFR1B1A	DIODE	[M]
24	SNE2123	EARTH TERMINAL	[M]	Q802	2SC1740SSTA	TRANSISTOR	[M]	D102	MA1651A	DIODE	[M]
25	SNE2129-1	SCREW (CABINET)	[M]	Q803	2SC1740SSTA	TRANSISTOR	[M]	D351	MIZFR6B1A	DIODE	 [M]
26	XTB3+20JFZ	SCREW	[M]	Q804	2SC1740SSTA	TRANSISTOR	[M]	D352	MIZFR6B1A	DIODE	 [M]
27	XTB3+30J	SCREW (FAN)	[M]	Q805	R/1DTA113ZST	TRANSISTOR	[M]	D401	MIZFR6C1A	DIODE	[M]
28	XTB3+8FFZ	SCREW	[M]	Q806	R/1DTA113ZST	TRANSISTOR	[M]	D301	SE36L6008	DIODE	[M]
29	XTBS26+10J	SCREW (FRONT)	[M]	Q808	2SD1915FTA	TRANSISTOR	[M]	D302	SE36L6008	DIODE	[M]
30	XTBS3+8JFZ1	SCREW	[M]	Q801	2SD1915FTA	TRANSISTOR	[M]	D305	R/1D1S133TA	DIODE	[M]
31	XTW3+15T	SCREW	[M]	Q802	2SD1915FTA	TRANSISTOR	[M]	D306	R/1D1S133TA	DIODE	[M]
				Q101	2SD2374PQAU	TRANSISTOR	 [M]	D308	MIZFR2B1A	DIODE	[M]
		INTEGRATED CIRCUITS		Q103	2SC1740SSTA	TRANSISTOR	 [M]	D701	1N6402BM21	DIODE	 [M]
IC101	LA1832A	IC, IF/MPX	[M]	Q104	2SC1740SSTA	TRANSISTOR	 [M]	D702	1N6402BM21	DIODE	 [M]
IC102	LC7218	IC, PLL	[M]	Q106	2SC3940QSTA	TRANSISTOR	[M]	D703	1N6402BM21	DIODE	 [M]
IC351	NUM2279D	IC, VIDEO SELECTOR	[M]	Q107	2SB621AQSTA	TRANSISTOR	 [M]	D704	1N6402BM21	DIODE	 [M]
IC401	TC9163AN	IC, SELECTOR	[M]	Q108	2SB1548PQAU	TRANSISTOR	 [M]				

Ref No.	Part No.	Part Name & Description	Remarks	Ref No.	Part No.	Part Name & Description	Remarks	Ref No.	Part No.	Part Name & Description	Remarks
D75	MTZBR2BTA	DIODE	 [M]	S980	EVQ240BR	SW,TUNER	[M]	L105	RLQZB82KTD	TAPINGCOIL	[M]
D77	MTZLZD7TA	DIODE	 [M]	S981	EVQ240BR	SW,CD	[M]	L106	RLQZB82KTD	TAPINGCOIL	[M]
D78	MTZK8CTA	DIODE	 [M]	S982	EVQ240BR	SW,TAPE	[M]	L151	SLM1B10-1M	A.B.FILTER	[M]
D721	1N640BM21	DIODE	 [M]	S983	EVQ240BR	SW,TVIDVD	[M]	L191	ELESNFB8VA	CHOKECOIL	[M]
D722	1N640BM21	DIODE	 [M]	S984	EVQ240BR	SW,VCR	[M]	L801	RLQZP1R0KFY	AXIALCOIL	[M]
D723	1N640BM21	DIODE	 [M]	S970	EVQ240BR	SW,SEARCH	[M]	L802	RLQZP1R0KFY	AXIALCOIL	[M]
D724	1N640BM21	DIODE	 [M]	S971	EVQ240BR	SW,EON	[M]	L801	RLQYF73MWE	CHOKECOIL	[M]
D731	MTZL2D7TA	DIODE	 [M]	S972	EVQ240BR	SW,PTYUP	[M]	L802	RLQYF73MWE	CHOKECOIL	[M]
D732	RVD1SS133TA	DIODE	[M]	S973	EVQ240BR	SW,PTYDOWN	[M]	L803	RLQYF73MWE	CHOKECOIL	[M]
D733	RVD1SS133TA	DIODE	[M]	S974	EVQ240BR	SW,DISPLAYMODE	[M]	L804	RLQYF73MWE	CHOKECOIL	[M]
D751	1SR3520TB	DIODE	 [M]	S980	EVQ240BR	SW,SPEAKERS	[M]	L751	ELESN101KA	CHOKECOIL	[M]
D752	1SR3520TB	DIODE	 [M]	S983	EVQ240BR	SW,OFFON	[M]	L791	SLQZBF0M49	ACLINCOIL	 [M]
D753	1SR3520TB	DIODE	 [M]	S984	EVQ240BR	SW,FROLOGIC	[M]	L901	RLQB101KTAY	CHOKECOIL	[M]
D754	1SR3520TB	DIODE	 [M]	S985	EVQ240BR	SW,CENTERMODE	[M]	L902	RLQZP101KTY	AXIALCOIL	[M]
D755	RVD1SS133TA	DIODE	 [M]					L1051	ELESN101KA	CHOKECOIL	[M]
D756	MTZBR2BTA	DIODE	 [M]			CONNECTORS		T701	RTP1NEB025X	POWERTRANSFORMER	[M] 
D771	RVD1SS133TA	DIODE	[M]	CN101RJU057M007		7PCONNECTOR	[M]	T751	RTP1EE006	TRANSFORMER(SMALL)	[M] 
D772	RVD1SS133TA	DIODE	[M]	CN102RJU057M007		7PCONNECTOR	[M]				
D773	MTZBR1CTA	DIODE	[M]	CN401RJU100M007		7PCONNECTOR	[M]			COMPONENT COMBINATION	
D775	RVD1SS133TA	DIODE	[M]	CN402RJU100M007		7PCONNECTOR	[M]	Z01	FLA2Z02MFT	AVANT.COIL	[M]
D781	RVD1SS133TA	DIODE	[M]	CN501RJU100M007		7PCONNECTOR	[M]	Z02	RLZ208MFT	AMFT	[M]
D782	RVD1SS133TA	DIODE	[M]	CN602RJU100M004		4PCONNECTOR	[M]	Z10	EW1728G1R	FMTUNERPACK	[MEG]
D801	1SS291TA	DIODE	[M]	CN701A	RJS1A8804T1	4PTAPINGCONNECTOR	[M]	Z10	EW1728G1Y	FMTUNERPACK	[MEB E]
D803	MTZHR2BTA	DIODE	[M]	CN701B	RJS1A8804T1	4PTAPINGCONNECTOR	[M]	Z51	EPZ10V511CS	ZR	 [M]
D821	RVD1SS133TA	DIODE	[M]	CN701C	RJS1A8804T1	4PTAPINGCONNECTOR	[M]	Z81	RCDSPS4242N	REMOTESENSOR	[M]
D823	RVD1SS133TA	DIODE	[M]	CN751	SJS305-1	3PCONNECTOR	[M]				
D824	MTZBR9ATA	DIODE	 [M]	CN752RUS1A6803T1		3PINTAPINGCONNECT	[M]			CERAMICFILTERS	
D825	RVD1SS133TA	DIODE	[M]	CN801RJU003K008M1		BOADINCONNECTOR	[M]	CF201RUFETINGD01L		CERAMICFILTER	[M]
D829	LN84FRPH	DIODE	[M]	CN802RJU003K008M1		BOADINCONNECTOR	[M]	CF202RUFETINGD01L		CERAMICFILTER	[M]
D1001	MTZK0CTA	DIODE	 [M]	CN803RJU003K008M1		BOADINCONNECTOR	[M]	CF901RVCBST4R00MT		CERAMICOSOLLATOR	[M]
				CN804RJU003K008M1		BOADINCONNECTOR	[M]	CF902RSKZ458KM07M		CERAMICOSOLLATOR	[M]
		VARIABLERESISTORS		CN805RJU003K008M1		BOADINCONNECTOR	[M]	CF1051	EFUEC8004T4	CERAMICOSOLLATOR	[M]
VR501EJUMWRH026B15		VRMOTOR	[M]	CP101	RJT057M007-1	7PCONNECTOR	[M]				
VR502EJUMQ0F01G15		VRBALANCECONTROL	[M]	CP102	RJT057M007-1	7PCONNECTOR	[M]			OSILLATORS	
VR511EJUYA1F01C15		VRTONECONTROL	[M]	CP401	RJT100M07	7PCONNECTOR	[M]	X101	RSX2458M07M	CERAMICOSOLLATOR	[M]
VR512EJUYA1F01C15		VRTONECONTROL	[M]	CP402	RJT100M07	7PCONNECTOR	[M]	X102	RLFDGTD011	FVREZONATOR	[M]
				CP501	RJT100M07	7PCONNECTOR	[M]	X103	SLQ49J7ZTS	CERAMIC7.2MHz	[M]
		SWITCHES		CP502	RJT100M04	4PCONNECTOR	[M]				
S946	EVQ240BR	SW,POWER	[M]	CP771	RJP3G4YA	CONNECTOR	[M]			DISPLAYTUBE	
S947	EVQ240BR	SW,PHONO	[M]	CP901	RJT003K008M1	8PCONNECTOR	[M]	FL901	RSL0233F	FL	[M]
S948	EVQ240BR	SW,MUTING	[M]	CP902	RJT003K008M1	8PCONNECTOR	[M]				
S950	EVQ240BR	SW,FM MODE	[M]	CP903	RJT003K008M1	8PCONNECTOR	[M]			EARTHTERMINALS	
S951	EVQ240BR	SW,BAND	[M]	CP904	RJT003K008M1	8PCONNECTOR	[M]	E401	SNE10042	EARTH-TERMINAL	[M]
S952	EVQ240BR	SW,TUNINGDOWN	[M]	CP905	RJT003K008M1	8PCONNECTOR	[M]	E801	SNE10042	EARTH-TERMINAL	[M]
S953	EVQ240BR	SW,TUNINGUP	[M]								
S955	EVQ240BR	SW,MEMORY	[M]			COILS&TRANSFORMERS				FUSES	
S956	EVQ240BR	SW,PRESETDOWN	[M]	L101	ELESN1010VA	CHOKECOIL	[M]	F1	XB42C20TB0	FUSE	 [M]
S957	EVQ240BR	SW,PRESETUP	[M]	L103	ELEXT1R47M49	CHOKECOIL	[M]	F8	XB42C30TB0	FUSE	 [M]

Ref No.	Part No.	Part Name & Description	Remarks	Ref No.	Part No.	Part Name & Description	Remarks	Ref No.	Part No.	Part Name & Description	Remarks
R4	XBA2C307B0	FUSE	[M]	J402	SJF308N	JK,LINEIN	[M]	A2	RJA00192K	ACCORD (SF)	[MEGE]
				J403	SJF308N	JK,LINEIN	[M]	A2	VJA073	ACCORD (SF)	[MEB]
		FUSECLIPS		J404	SJF308N	JK,LINEIN	[M]	A3	RFKSE310EK	INSTR.MANUALASSY	[ME]
FC701EYF52BC		FUSEHOLDER	[M]	J405	SJF07	JK,FMULTIOUT	[M]	A3	RFKSE310EEK	INSTR.MANUALASSY	[MEB]
FC702EYF52BC		FUSEHOLDER	[M]	J601	RJH801	JK,SPTERMINAL	[M]	A3	RFKSE310EGK	INSTR.MANUALASSY	[MEG]
FC703EYF52BC		FUSEHOLDER	[M]	J602	RJ0064	JK,SPTERMINAL	[M]	A4	RS4007	RMANTEVA	[M]
FC704EYF52BC		FUSEHOLDER	[M]	J794	SJS9231-1B	JK,ACIN	[M]	A5	RS4010	LOOPANTUNIT	[M]
FC705EYF52BC		FUSEHOLDER	[M]					A6	SJF009	ANTADAPTER	[MEB]
FC706EYF52BC		FUSEHOLDER	[M]			HEADPHONE		A7	SPSD152	ACCESSORYBOX	[M]
				HF01	RJ63TS01	HEADPHONEJACK	[M]	A8	RF0382	GFTBOX	[MEBEG]
		RELAYS									
RL01	RSY0013M0	RELAY	[M]			PACKINGMATERIALS				WRE	
RL02	RSY0013M0	RELAY	[M]	P1	RF0362	PACKINGCASE	[ME]	W1	REED814	WRE	[M]
RL51	RSY0019M0	12VTV-5RELAY	[M]	P2	RF0005	MRAMTBAG	[M]	V2	REED818	WRE	[M]
				P3	RFN085	POLYFOAM	[M]				
		JACKS									
JK101	RJH202	JK,ANTTERMINAL	[M]			ACCESSORIES					
JK51	SJF3083N	JK,RCAPIN	[M]	A1	ELR64377	REMOTECNTRCL	[M]				
JK401	SJF3087N	JK,RCATERMINAL	[M]	A1-1	UR64EC18223	REMOTECNTRCOVER	[M]				

Resistors & Capacitors

Notes : * Important safety notice:

Components identified by mark have special characteristics important for safety.

Furthermore, special parts which have purposes of fire-retardant (resistors), high-quality sound (capacitors), low-noise (resistors), etc. are used. When replacing any of components, be sure to use only manufacturer's specified parts shown in the parts list.

* Capacitor values are in microfarad (μF) unless specified otherwise, P=Pico-farads (pF) F=Farads (F)

* Resistors values are in ohms, unless specified otherwise, 1k=1,000(OHM), 1M=1,000k(OHM)

Ref No.	Part No.	Values & Remarks	Ref No.	Part No.	Values & Remarks	Ref No.	Part No.	Values & Remarks	Ref No.	Part No.	Values & Remarks
	RESISTORS		R124	ERDS2TJ271T	270 14W [M]	R144	ERDS2TJ222T	22K 14W [M]	R38	ERDS2TJ102T	1K 14W [M]
			R125	ERDS2TJ472T	47K 14W [M]	R145	ERDS2TJ102T (EBE)	1K 14W [M]	R39	ERDS2TJ182T	18K 14W [M]
R103	ERDS2TJ101T	10 14W [M]	R126	ERDS2TJ472T	47K 14W [M]	R146	ERDS2TJ561T (EG)	50 14W [M]	R30	ERDS2TJ182T	18K 14W [M]
R104	ERDS2TJ102T	1K 14W [M]	R127	ERDS2TJ103T	10K 14W [M]	R146	ERDS2TJ102T (EBE)	1K 14W [M]	R31	ERDFCVG220T	2 14W [M]
R105	ERDS2TJ471T	40 14W [M]	R128	ERDS2TJ820T	8 14W [M]	R146	ERDS2TJ561T (EG)	50 14W [M]	R32	ERDFCVG220T	2 14W [M]
R106	ERDS2TJ224T	22K 14W [M]	R129	ERDS2TJ473T	47K 14W [M]	R147	ERDS2TJ474T	470K 14W [M]	R33	ERDS2TJ103T	10K 14W [M]
R107	ERDS2TJ471T	40 14W [M]	R130	ERDS2TJ102T	1K 14W [M]	R148	ERDS2TJ474T	470K 14W [M]	R34	ERDS2TJ103T	10K 14W [M]
R110	ERDS2TJ102T	1K 14W [M]	R131	ERDS2TJ102T	1K 14W [M]	R149	ERDS2TJ680T	68 14W [M]	R401	ERDS2TJ102T	1K 14W [M]
R112	ERDS2TJ104T	100K 14W [M]	R132	ERDS2TJ103T	10K 14W [M]	R171	ERDS2TJ102T	1K 14W [M]	R402	ERDS2TJ102T	1K 14W [M]
R113	ERDS2TJ103T	10K 14W [M]	R133	ERDS2TJ102T	1K 14W [M]	R172	ERDS2TJ102T	1K 14W [M]	R405	ERDS2TJ102T	1K 14W [M]
R114	ERDS2TJ662T	56K 14W [M]	R134	ERDS2TJ102T	1K 14W [M]	R173	ERDS2TJ471T	40 14W [M]	R406	ERDS2TJ102T	1K 14W [M]
R115	ERDS2TJ661T	50 14W [M]	R135	ERDS2TJ102T	1K 14W [M]	R175	ERDS2TJ102T	1K 14W [M]	R407	ERDS2TJ102T	1K 14W [M]
R116	ERDS2TJ102T	1K 14W [M]	R136	ERDS2TJ102T	1K 14W [M]	R176	ERDS2TJ891T	30 14W [M]	R408	ERDS2TJ102T	1K 14W [M]
R117	ERDS2TJ473T	47K 14W [M]	R137	ERDS2TJ102T	1K 14W [M]	R181	ERDS2TJ832T	33K 14W [M]	R409	ERDS2TJ102T	1K 14W [M]
R118	ERDS2TJ662T	56K 14W [M]	R139	ERDS2TJ272T	27K 14W [M]	R301	ERDS2TJ750T	75 14W [M]	R410	ERDS2TJ102T	1K 14W [M]
R119	ERDS2TJ183T	18K 14W [M]	R140	ERDS2TJ272T	27K 14W [M]	R302	ERDS2TJ750T	75 14W [M]	R411	ERDS2TJ102T	1K 14W [M]
R120	ERDS2TJ473T	47K 14W [M]	R141	ERDS2TJ102T	1K 14W [M]	R309	ERDS2TJ750T	75 14W [M]	R412	ERDS2TJ102T	1K 14W [M]
R121	ERDS2TJ332T	33K 14W [M]	R142	ERDS2TJ102T	1K 14W [M]	R302	ERDS2TJ750T	75 14W [M]	R413	ERDS2TJ102T	1K 14W [M]
R122	ERDS2TJ272T	27K 14W [M]	R143	ERDS2TJ222T	22K 14W [M]	R367	ERDS2TJ102T	1K 14W [M]	R414	ERDS2TJ102T	1K 14W [M]

Ref No.	Part No.	Values & Remarks	Ref No.	Part No.	Values & Remarks	Ref No.	Part No.	Values & Remarks	Ref No.	Part No.	Values & Remarks
R740	ERDS2J.033T	3K 14V [M]	R90	ERDS2J.103T	10K 14V [M]				C48	ECBT1C103N65	001 16V [M]
R742	ERDS2J.033T	3K 14V [M]	R90	ERDS2J.102T	K 14V [M]		CAPACITORS		C49	ECBT1C103N65	001 16V [M]
R743	ERDS2J.183T	18K 14V [M]	R91	ERDS2J.122T	12K 14V [M]	C101	ECBT1C103N65	001 16V [M]	C130	ECBT1H102F5	01 50V [M]
R754	ERDS2J.102T	1K 14V [M]	R92	ERDS2J.152T	15K 14V [M]	C103	ECBT1C103N65	001 16V [M]	C172	ECBT1H331K65	33P 50V [M]
R771	ERDS2J.473T	47K 14V [M]	R93	ERDS2J.182T	18K 14V [M]	C104	ECBT1H102K65	100P 50V [M]	C173	ECEA1CKA220B	2 16V [M]
R772	ERDS2J.473T	47K 14V [M]	R94	ERDS2J.222T	22K 14V [M]	C105	ECBT1H470.5	4P 50V [M]	C174	ECEA1CKA101B	10 16V [M]
R773	ERDS2J.103T	10K 14V [M]	R95	ERDS2J.332T	33K 14V [M]	C106	ECBT1C103N65	001 16V [M]	C175	ECBT1C103N65	001 16V [M]
R774	ERDS2J.336T	33M 14V [M]	R96	ERDS2J.472T	47K 14V [M]	C107	ECBT1H473F5	0047 50V [M]	C176	ECBT1C103N65	001 16V [M]
R775	ERDS2J.331T	33 14V [M]	R97	ERDS2J.682T	68K 14V [M]	C108	ECBT1H82K5	82P 50V [M]	C181	ECBT1H471K65	47P 50V [M]
R776	ERDS2J.477T	47 14V [M]	R98	ERDS2J.102T	K 14V [M]	C109	ECBT1C103N65	001 16V [M]	C186	ECBT1H102K65	100P 50V [M]
R777	ERDS2J.224T	22K 14V [M]	R99	ERDS2J.122T	12K 14V [M]	C110	ECBT1C103N65	001 16V [M]	C330	ECBT1H470.5	4P 50V [M]
R778	ERDS2J.472T	47K 14V [M]	R92	ERDS2J.152T	15K 14V [M]	C111	ECEA1EK44R7B	47 25V [M]	C331	ECBT1H470.5	4P 50V [M]
R779	ERDS2J.103T	10K 14V [M]	R93	ERDS2J.182T	18K 14V [M]	C112	ECBT1C103N65	001 16V [M]	C332	ECR1H223F5	0022 50V [M]
R782	ERDS2J.470T	47 14V [M]	R94	ERDS2J.222T	22K 14V [M]	C113	ECBT1H102K65	100P 50V [M]	C333	ECR1H223F5	0022 50V [M]
R783	ERDS2J.103T	10K 14V [M]	R90	ERDS2J.102T	K 14V [M]	C114	ECEA1HKA3R3B	33 50V [M]	C351	ECEA1CU101B	10 16V [M]
R784	ERDS2J.154T	15K 14V [M]	R91	ERDS2J.122T	12K 14V [M]	C115	ECEA1EK44R7B	47 25V [M]	C352	ECEA1CU101B	10 16V [M]
R785	ERDS2J.103T	10K 14V [M]	R92	ERDS2J.152T	15K 14V [M]	C116	ECBT1C322M65	820P 16V [M]	C354	ECBT1E1032F5	001 25V [M]
R786	ERDS2J.154T	15K 14V [M]	R93	ERDS2J.182T	18K 14V [M]	C117	ECBT1H471UF3	47P 50V [M]	C355	ECBT1E1032F5	001 25V [M]
R787	ERDS2J.223T	22K 14V [M]	R94	ERDS2J.222T	22K 14V [M]	C118	ECOB1H103F3	001 50V [M]	C357	ECBT1E1032F5	001 25V [M]
R788	ERDS2J.223T	22K 14V [M]	R90	ERDS2J.102T	K 14V [M]	C119	ECOB1H103F3	001 50V [M]	C358	ECBT1E1032F5	001 25V [M]
R789	ERDS2J.223T	22K 14V [M]	R91	ERDS2J.122T	12K 14V [M]	C120	ECEA1HKA010B	1 50V [M]	C373	ECA1EM470B	47 25V [M]
R790	ERDS2J.223T	22K 14V [M]	R92	ERDS2J.152T	15K 14V [M]	C121	ECEA1HKA010B	1 50V [M]	C374	ECA1EM470B	47 25V [M]
R793	ERDS2J.682T	68K 14V [M]	R93	ERDS2J.182T	18K 14V [M]	C122	ECEA1HKA2R2B	22 50V [M]	C401	ECEA1NK44R7B	47 35V [M]
R794	ERDS2J.682T	68K 14V [M]	R95	ERDS2J.222T	22K 14V [M]	C123	ECEA1HKA010B	1 50V [M]	C402	ECEA1NK44R7B	47 35V [M]
R801	ERDS2J.102T	1K 14V [M]	R1001	ERDS2J.223T	22K 14V [M]	C124	ECBT1H102K65	100P 50V [M]	C403	ECBT1E1032F5	001 25V [M]
R806	ERDS2J.182T	18K 14V [M]	R1002	ERDS2J.223T	22K 14V [M]	C125	ECBT1H150J5	1P 50V [M]	C404	ECBT1E1032F5	001 25V [M]
R807	ERDS2J.104T	10K 14V [M]	R1003	ERDS2J.102T	K 14V [M]	C126	ECBT1H102F5	01 50V [M]	C405	ECBT1H101K65	10P 50V [M]
R808	ERDS2J.104T	10K 14V [M]	R1004	ERDS2J.102T	K 14V [M]	C127	ECEA1CKA220B	2 16V [M]	C406	ECBT1H101K65	10P 50V [M]
R809	ERDS2J.104T	10K 14V [M]	R1005	ERDS2J.203T	20K 14V [M]	C128	ECBT1C103N65	001 16V [M]	C409	ECEA1CKA100B	0 16V [M]
R810	ERDS2J.102T	1K 14V [M]	R1007	ERDS2J.473T	47K 14V [M]	C129	ECEA1UKA101B	10 63V [M]	C410	ECEA1CKA100B	0 16V [M]
R811	ERDS2J.104T	10K 14V [M]	R1008	ERDS2J.473T	47K 14V [M]	C130	ECEA1UKA101B	10 63V [M]	C411	ECBT1H101K65	10P 50V [M]
R817	ERDS2J.103T	10K 14V [M]	R1009	ERDS2J.332T	33K 14V [M]	C131	ECBT1C103N65	001 16V [M]	C412	ECBT1H101K65	10P 50V [M]
R820	ERDS2J.271T	27 14V [M]	R1010	ERDS2J.332T	33K 14V [M]	C132	ECBT1H102K65	100P 50V [M]	C415	ECBT1E1032F5	001 25V [M]
R821	ERDS2J.121T	12 14V [M]	R1011	ERDS2J.332T	33K 14V [M]	C133	ECBT1H150J5	1P 50V [M]	C416	ECBT1E1032F5	001 25V [M]
R822	ERDS2J.472T	47K 14V [M]	R1012	ERDS2J.102T	K 14V [M]	C134	ECBT1H150J5	1P 50V [M]	C417	ECBT1H101K65	10P 50V [M]
R824	ERDS2J.333T	33K 14V [M]	R1016	ERD2FO.688T	68 14V [M]	C135	ECBT1C103M65	001 16V [M]	C418	ECBT1H101K65	10P 50V [M]
R827	ERDS2J.181T	18 14V [M]	R1051	ERDS2J.033T	3K 14V [M]	C136	ECBT1C103M65	001 16V [M]	C419	ECBT1H331K65	33P 50V [M]
R829	ERDS2J.101T	10 14V [M]	R1052	ERDS2J.105T	1M 14V [M]	C137	ECBT1H551K65	50P 50V [M]	C420	ECBT1H331K65	33P 50V [M]
R830	ERDS2J.101T	10 14V [M]	R1053	ERDS2J.102T	K 14V [M]	C138	ECBT1H551K65	50P 50V [M]	C421	ECBT1H331K65	33P 50V [M]
R836	ERDS2J.104T	10K 14V [M]	R1055	ERDS2J.473T	47K 14V [M]	C139	ECOB1H682F3	680P 50V [M]	C422	ECBT1H331K65	33P 50V [M]
R837	ERDS2J.104T	10K 14V [M]	R1056	ERDS2J.473T	47K 14V [M]	C140	ECOB1H682F3	680P 50V [M]	C423	ECBT1H101K65	10P 50V [M]
R841	ERDS2J.472T	47K 14V [M]	R1061	ERDS2J.222T	22K 14V [M]	C141	ECEA1HKA010B	1 50V [M]	C424	ECBT1H101K65	10P 50V [M]
R843	ERDS2J.102T	1K 14V [M]				C142	ECEA1HKA010B	1 50V [M]	C425	ECBT1H101K65	10P 50V [M]
R844	ERDS2J.104T	10K 14V [M]				C143	ECEA1HKA010B	1 50V [M]	C426	ECBT1H101K65	10P 50V [M]
R845	ERDS2J.104T	10K 14V [M]				C144	ECEA1HKA010B	1 50V [M]	C427	ECBT1H221K65	22P 50V [M]
R846	ERDS2J.103T	10K 14V [M]				C145	ECBT1H220J5	2P 50V [M]	C428	ECBT1H221K65	22P 50V [M]
R847	ERDS2J.103T	10K 14V [M]				C146	ECBT1H331K65	33P 50V [M]	C431	ECEA1CKA100B	0 16V [M]
R848	ERDS2J.103T	10K 14V [M]				C147	ECBT1H102K65	100P 50V [M]	C432	ECEA1CKA100B	0 16V [M]

Ref No.	Part No.	Values & Remarks	Ref No.	Part No.	Values & Remarks	Ref No.	Part No.	Values & Remarks	Ref No.	Part No.	Values & Remarks
C40	ECBT1E102ZF5	001 2V [M]	C551	ECEA1HKA3R3B	33 5V [M]	C68	ECBT1H101K65	10P 5V [M]	C92	ECEA1HKA22B	2 5V [M]
C41	ECEA1VKA4R7B	47 3V [M]	C552	ECEA1HKA3R3B	33 5V [M]	C69	ECBT1H102K65	100P 5V [M]	C93	ECEA1VKA100B	0 3V [M]
C42	ECEA1VKA4R7B	47 3V [M]	C553	ECBT1H101K65	10P 5V [M]	C70	ECKR1H22ZF5	0022 5V [M]	C94	ECEA1VKA100B	0 3V [M]
C43	ECBT1H100C5	1P 5V [M]	C554	ECBT1H101K65	10P 5V [M]	C71	ECQV1H104UM3	01 5V [M]	C95	ECEA1HKA010B	1 5V [M]
C44	ECBT1H100C5	1P 5V [M]	C555	ECBT1H221K65	22P 5V [M]	C72	ECQV1H104UM3	01 5V [M]	C97	ECEA1HKA4R7B	047 5V [M]
C45	ECBT1H102K65	100P 5V [M]	C556	ECBT1H221K65	22P 5V [M]	C73	ECQV1H104UM3	01 5V [M]	C98	ECEA1HKA221B	20 63V [M]
C46	ECBT1H102K65	100P 5V [M]	C557	ECBT1E103ZF5	001 2V [M]	C74	ECQV1H104UM3	01 5V [M]	C99	ECEA1HKA010B	1 5V [M]
C47	ECA10M330B	3 16V [M]	C558	ECBT1E103ZF5	001 2V [M]	C75	ECBT1C332R5	330P 16V [M]	C92	ECBT1H101K65	10P 5V [M]
C48	ECA10M330B	3 16V [M]	C559	ECEA1CKA100B	0 16V [M]	C76	ECBT1C332R5	330P 16V [M]	C99	ECBT1H101K65	10P 5V [M]
C49	ECFR1E223R	0022 2V [M]	C560	ECEA1CKA100B	0 16V [M]	C77	ECBT1E103ZF5	001 2V [M]	C94	ECBT1E103ZF5	001 2V [M]
C49	ECFR1E223R	0022 2V [M]	C561	ECA1HMFR3B	33 5V [M]	C78	ECBT1E103ZF5	001 2V [M]	C92	ECBT1H101K65	10P 5V [M]
C461	ECBT1C332R5	680P 16V [M]	C562	ECA1HMFR3B	33 5V [M]	C79	ECQE2104F3	01 25V [M]	C93	ECBT1H101K65	10P 5V [M]
C42	ECBT1C332R5	680P 16V [M]	C563	ECBT1H102ZF5	01 5V [M]	C78	ECOS1H682BB	680P 5V [M]	C96	ECBT1H101K65	10P 5V [M]
C43	ECEA1VKA4R7B	47 3V [M]	C601	ECA10M330B	3 16V [M]	C74	ECOS1H682BB	680P 5V [M]	C61	ECBT1H101K65	10P 5V [M]
C44	ECEA1VKA4R7B	47 3V [M]	C62	ECA10M330B	3 16V [M]	C75	ECOS1P532BB	530P 3V [M]	C101	ECEA1HJ010B	1 5V [M]
C45	ECBT1E103ZF5	001 2V [M]	C63	ECEA1VKA4R7B	47 3V [M]	C76	ECOS1P532BB	530P 3V [M]	C102	ECEA1HJ010B	1 5V [M]
C46	ECBT1E103ZF5	001 2V [M]	C64	ECEA1VKA4R7B	47 3V [M]	C77	ECA1VM101B	10 3V [M]	C103	ECA1HMFR3B	33 5V [M]
C49	ECBT1H181K65	18P 5V [M]	C65	ECA1UM330B	3 63V [M]	C78	ECKR1H103ZF5	001 5V [M]	C104	ECA1HMFR3B	33 5V [M]
C47	ECBT1H181K65	18P 5V [M]	C66	ECA1UM330B	3 63V [M]	C79	ECA10M330B	3 16V [M]	C105	ECEA1HJ010B	1 5V [M]
C33	ECEA1JKA101B	10 63V [M]	C67	ECA1UM330B	3 63V [M]	C70	ECBT1E103ZF5	001 2V [M]	C107	ECFR1E223R	0022 2V [M]
C34	ECEA1JKA101B	10 63V [M]	C68	ECA1UM330B	3 63V [M]	C71	ECKR1H103ZF5	001 5V [M]	C108	ECFR1E473R	0047 2V [M]
C35	ECFR1C10MR	01 16V [M]	C69	ECOR1H120K5	1P 5V [M]	C72	ECA1HM100B	0 5V [M]	C109	ECEA1J221B	20 63V [M]
C36	ECFR1C10MR	01 16V [M]	C60	ECOR1H120K5	1P 5V [M]	C73	ECKR1H103ZF5	001 5V [M]	C10	ECEA1CKA100B	0 16V [M]
C511	ECEA1HKA3R3B	33 5V [M]	C611	ECOR1H120K5	1P 5V [M]	C74	ECA1EM470B	4 2V [M]	C1011	ECEA1CKA100B	0 16V [M]
C512	ECEA1HKA3R3B	33 5V [M]	C612	ECOR1H120K5	1P 5V [M]	C75	ECEA1JU101B	10 16V [M]	C1012	ECEA1CKA100B	0 16V [M]
C513	ECBT1H150L5	1P 5V [M]	C613	ECBT1H221K65	22P 5V [M]	C71	ECQE2104F3	01 25V [M]	C1013	ECEA1CKA100B	0 16V [M]
C514	ECBT1H150L5	1P 5V [M]	C614	ECBT1H221K65	22P 5V [M]	C731	ECKR1H103ZF5	001 5V [M]	C1014	ECEA1J221B	20 63V [M]
C515	ECBT1H221K65	22P 5V [M]	C615	ECBT1H221K65	22P 5V [M]	C72	ECKR1H103ZF5	001 5V [M]	C1015	ECQV1H104UM3	01 5V [M]
C516	ECBT1H221K65	22P 5V [M]	C616	ECBT1H221K65	22P 5V [M]	C751	ECKVRS102MBC	100P 40V [M]	C1016	ECQV1H104UM3	01 5V [M]
C517	ECBT1H330L5	3P 5V [M]	C617	ECQV1H473J23	0047 5V [M]	C72	ECKR1H103ZF5	001 5V [M]	C1017	ECA1HMFR47B	047 5V [M]
C518	ECBT1H330L5	3P 5V [M]	C618	ECQV1H473J23	0047 5V [M]	C73	ECA1EM102EV	100 2V [M]	C1018	ECEA1VKA4R7B	47 3V [M]
C519	ECEA1VKA4R7B	47 3V [M]	C619	ECQV1H473J23	0047 5V [M]	C74	ECBT1E103ZF5	001 2V [M]	C1019	ECA1HMFR47B	047 5V [M]
C520	ECEA1VKA4R7B	47 3V [M]	C620	ECQV1H473J23	0047 5V [M]	C75	ECA10M470B	4 16V [M]	C1020	ECEA1VKA4R7B	47 3V [M]
C521	ECEA1VKA4R7B	47 3V [M]	C621	ECEA2AU100B	0 10V [M]	C757	ECA10M100B	0 16V [M]	C1021	ECEA1HKA16B	015 5V [M]
C522	ECEA1VKA4R7B	47 3V [M]	C622	ECEA1HN105B	1 5V [M]	C71	ECEA1VKA4R7B	47 3V [M]	C1022	ECA1HMFR3B	33 5V [M]
C523	ECFR1E123R	0012 2V [M]	C623	ECA1HM470B	4 5V [M]	C72	ECEA1VKA4R7B	47 3V [M]	C1023	ECQV1H154J23	015 5V [M]
C524	ECFR1E123R	0012 2V [M]	C624	ECEA2ANR25B	22 10V [M]	C73	ECBT1E223ZF5	0022 2V [M]	C1024	ECQV1H154J23	015 5V [M]
C525	ECQV1H683UM3	0068 5V [M]	C625	ECEA1HN105B	0 5V [M]	C74	ECEA1JKA101B	10 63V [M]	C1025	ECA1HMFR3B	33 5V [M]
C526	ECQV1H683UM3	0068 5V [M]	C626	ECEA1HN105B	0 5V [M]	C75	ECBT1E223ZF5	0022 2V [M]	C1026	ECEA1HKA16B	015 5V [M]
C527	ECBT1C332R5	680P 16V [M]	C627	ECKR1H223ZF5	0022 5V [M]	C801	ECAQM102B	10006.3V [M]	C1027	ECEA1VKA4R7B	47 3V [M]
C528	ECBT1C332R5	680P 16V [M]	C628	ECKR1H223ZF5	0022 5V [M]	C802	ECBT1E223ZF5	0022 2V [M]	C1028	ECA1HMFR47B	047 5V [M]
C529	ECQB1H273JF3	0027 5V [M]	C629	ECKR1H223ZF5	0022 5V [M]	C83	ECBT1E103ZF5	001 2V [M]	C1029	ECEA1VKA4R7B	47 3V [M]
C530	ECQB1H273JF3	0027 5V [M]	C630	ECKR1H223ZF5	0022 5V [M]	C84	ECAQM102B	10006.3V [M]	C1030	ECA1HMFR47B	047 5V [M]
C531	ECBT1E103ZF5	001 2V [M]	C631	ECKR1H223ZF5	0022 5V [M]	C86	ECEA1JKA101B	10 63V [M]	C1031	ECQV1H104UM3	01 5V [M]
C532	ECBT1E103ZF5	001 2V [M]	C632	ECKR1H223ZF5	0022 5V [M]	C88	ECBT1E103ZF5	001 2V [M]	C1032	ECQV1H104UM3	01 5V [M]
C533	ECEA1CKA221B	2 16V [M]	C635	ECEA1VKA4R7B	47 3V [M]	C99	ECEA1HKA221B	2 5V [M]	C1033	ECA1EM470B	4 2V [M]
C534	ECEA1CKA221B	2 16V [M]	C636	ECEA1HN105B	1 5V [M]	C910	ECEA1HKA221B	2 5V [M]	C1034	ECQV1H474UM3	047 5V [M]
C536	ECBT1E103ZF5	001 2V [M]	C637	ECBT1H102K65	100P 5V [M]	C911	ECEA1HKA221B	2 5V [M]	C1035	ECBT1H681K65	680P 5V [M]

Ref No.	Part No.	Values & Remarks	Ref No.	Part No.	Values & Remarks	Ref No.	Part No.	Values & Remarks	Ref No.	Part No.	Values & Remarks
C106	ECBT1H101K65	10P 5V [M]	C104	ECEA0UJ221B	20 63V [M]	C105	ECBT1H881K65	66P 5V [M]			
C107	ECBT1H101K65	10P 5V [M]	C105	ECA1HMR47B	0.47 5V [M]	C107	ECBT1C1524F5	150P 16V [M]			
C108	ECBT1H101K65	10P 5V [M]	C106	EQQV1H823Z3	0.082 5V [M]	C108	ECBT1C1524F5	150P 16V [M]			
C109	ECEA1CU101B	10 16V [M]	C107	ECBT1C3324F5	330P 16V [M]						
C100	ECEA1CKA100B	0 16V [M]	C108	EQQV1H823Z3	0.082 5V [M]						
C101	ECBT1E1032F5	0.01 2V [M]	C109	ECEA1CU101B	10 16V [M]						
C101	ECA1HMR2B	22 5V [M]	C100	ECBT1E2232F5	0.022 2V [M]						
C102	ECA1HMR3B	0.33 5V [M]	C102	ECBT1E2232F5	0.022 2V [M]						
C103	ECA1HMR3B	33 5V [M]	C103	ECEA1CU101B	10 16V [M]						

■ Packaging (Refer to page 41 for the Parts List.)

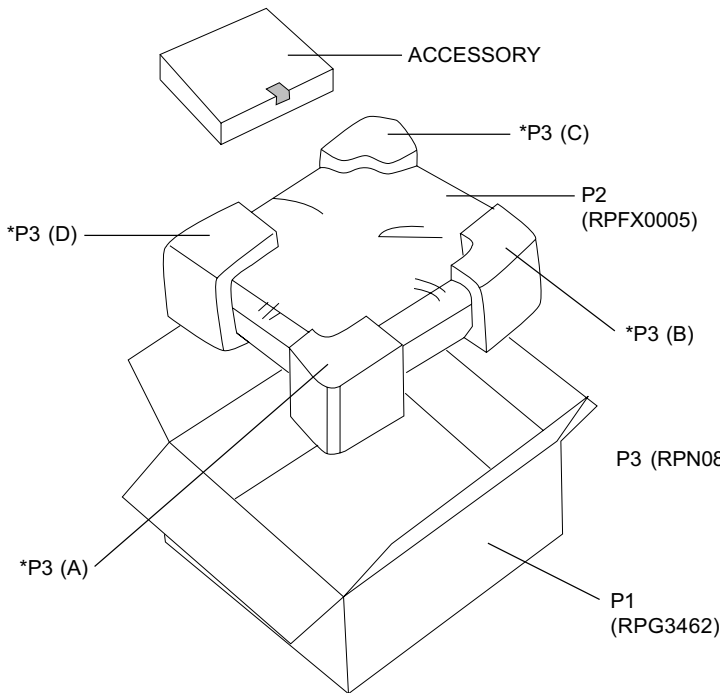

ACCESSORY

A1 (EUR644377)	: REMOTE CONTROL UNIT
A2 (RJA0019-2K ...E, EG)	: AC CORD
A2 (VJA0733 ...EB)	: AC CORD
A3 (RFKSEX310EK ... E)	: INSTR. MANUAL ASS'Y
A3 (RFKSEX310EBK ... EB)	: INSTR. MANUAL ASS'Y
A3 (RFKSEX310EGK ... EG)	: INSTR. MANUAL ASS'Y
A4 (RSA0007)	: FM ANTENA
A5 (RSA0010)	: LOOP ANT UNIT
A6 (SJP9009 ... EB)	: ANT ADAPTER
A7 (SPSD152)	: ACCESSORY BOX

- *P3 (A) - Front Left
- *P3 (B) - Front Right
- *P3 (C) - Rear Left
- *P3 (D) - Rear Right